



PERÇAGE



BOHREN



DRILLING















FORATURA











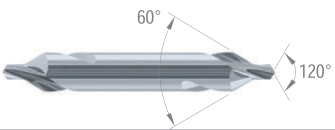

FÚRÁS

TALADRADO

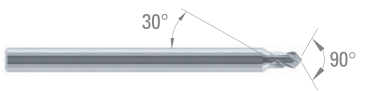
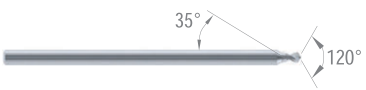
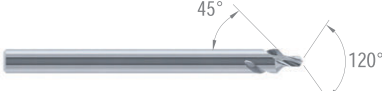
	SÉLECTION DES FORETS	4
	FORETS À CENTRER ET À POINTER	12
	MÈCHES À CANON HÉLICOÏDALES Z = 1	18
	FORETS HÉLICOÏDAUX CYLINDRIQUES	19
	FORETS HÉLICOÏDAUX CORPS RENFORCÉ	26
	FORETS HÉLICOÏDAUX AUTO-CENTRANTS	43
	FORETS HÉLICOÏDAUX AUTO-CENTRANTS À TROUS DE LUBRIFICATION	47
	FORETS HÉLICOÏDAUX ACIERS TREMPÉS > 45 HRC	51
	FORETS HÉLICOÏDAUX Z = 3	53
	FORETS POUR MATIÈRES COMPOSITES / KEVLAR®	57
	FORETS ÉTAGÉS ET OUTILS SUR DEMANDE	59
	GÉOMÉTRIE, INFORMATIONS	63
	CONDITIONS DE COUPE	64

SÉLECTION DES FORETS

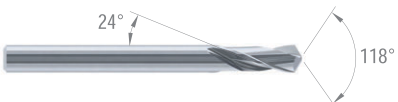
✓ = article de stock

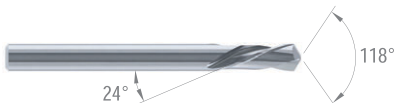
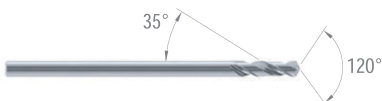
	Z	Page	L. coupe	<input type="checkbox"/> CARBURE	<input type="checkbox"/> TiAIN	<input type="checkbox"/> DICUT
FORETS À POINTER ET À CENTRER						
DIXI 1101 Ø 0.80 - 4.00 	2	12		✓		
DIXI 1106 Ø 1.00 - 20.00 	2	13		✓	✓	
DIXI 1106 L Ø 4.00 - 6.00 	2	14		✓		
DIXI 1107 Ø 1.00 - 20.00 	2	14		✓		
DIXI 1108 Ø 0.50 - 2.50 	2	15	1 - 2 x Ø	✓	✓	
DIXI 1109 Ø 0.50 - 2.50 	2	16	1 - 2 x Ø	✓		✓
DIXI 1110 Ø 0.80 - 1.45 	2	17	1 - 2 x Ø	✓	✓	
MÈCHES À CANON HÉLICOÏDALES Z = 1						
DIXI 1111 Ø 0.10 - 2.00 	1	18	4 - 9 x Ø	✓		
FORETS HÉLICOÏDAUX CYLINDRIQUES Z = 2						
DIXI 1126 Ø 1.00 - 14.00 	2	19	 7 - 12 x Ø	✓		✓
DIXI 1130 Ø 0.30 - 14.00 	2	20	 2 - 16 x Ø	✓		✓
DIXI 1130 L Ø 0.30 - 8.00 	2	22	4 - 16 x Ø	✓		✓
DIXI 1132 Ø 0.40 - 2.00 	2	24	4 - 15 x Ø	✓		✓



○ bien ⊙ excellent

Acier + Pb	Acier faibl. allié	Acier fort. allié	Acier inox aust.	Aciers Fontes 45-65 HRC	Fontes	Super alliages Ni / Co	Titane, alliages de titane	Alliage Cu Argent Or	Alliage Cu difficile	Alu	Graphite	Plastique
------------	--------------------	-------------------	------------------	-------------------------	--------	------------------------	----------------------------	----------------------	----------------------	-----	----------	-----------

⊙	○	○	○		⊙	○	○	⊙	○	⊙		⊙
⊙	⊙	○	⊙		⊙	○	⊙	⊙	⊙	⊙		⊙
⊙	⊙	○	⊙		⊙	○	⊙	⊙	⊙	⊙		⊙
⊙	⊙	○	⊙		⊙	○	⊙	⊙	⊙	⊙		⊙
⊙	⊙	○	⊙		⊙	○	⊙	⊙	⊙	⊙		⊙
⊙	⊙	○	⊙		⊙	○	⊙	⊙	⊙	⊙		⊙
⊙	⊙	○	⊙		⊙	○	⊙	⊙	⊙	⊙		⊙

⊙								⊙	⊙			
---	--	--	--	--	--	--	--	---	---	--	--	--

⊙	○	○	○		⊙	○	○	⊙	○	○	○	○
⊙	○	○			⊙		○	⊙	○	○	○	○
⊙	○	○			⊙		○	⊙	○	○	○	○
○	⊙	○	⊙		○	○	⊙	○	⊙	○	○	○



SÉLECTION DES FORETS

✓ = article de stock

* = pour matériaux non-ferreux

FORETS HÉLICOÏDAUX CYLINDRIQUES Z = 2

DIXI 1133
Ø 0.50 - 6.00

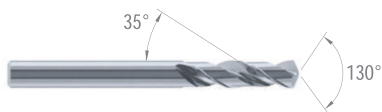

Z	Page	L. coupe	CARBURE	TITAIN	DICUT	DLC *
2	25	4 - 18 x Ø	✓		✓	

FORETS HÉLICOÏDAUX CORPS RENFORCÉ Z = 2

DIXI 1131
Ø 0.05 - 2.45



2	26	4 - 9 x Ø	✓		✓	✓*
---	----	-----------	---	--	---	----

DIXI 1131 L
Ø 0.10 - 2.45



2	29	4 - 9 x Ø	✓		✓	
---	----	-----------	---	--	---	--

DIXI 1134
Ø 0.50 - 1.95



2	32	6 - 9 x Ø	✓		✓	
---	----	-----------	---	--	---	--

DIXI 1135
Ø 0.20 - 2.49

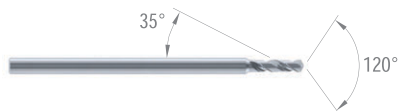

2	33	3 - 8 x Ø	✓		✓	
---	----	-----------	---	--	---	--

DIXI 1136
Ø 0.20 - 1.99



2	36	4 - 8 x Ø	✓		✓	
---	----	-----------	---	--	---	--

DIXI 1137
Ø 0.15 - 0.32

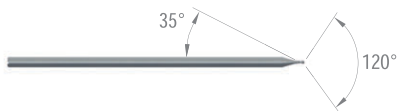

2	38	3 - 6 x Ø	✓			
---	----	-----------	---	--	--	--

DIXI 1138
Ø 0.05 - 2.80

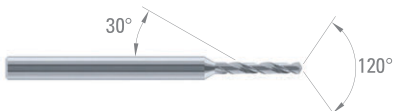

2	39	4 - 9 x Ø	✓	✓		
---	----	-----------	---	---	--	--

DIXI 1139
Ø 0.50 - 3.00

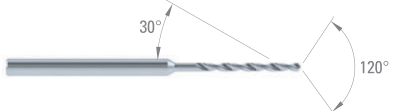

2	41	12 x Ø	✓	✓		
---	----	--------	---	---	--	--

FORETS HÉLICOÏDAUX AUTO-CENTRANTS Z = 2

DIXI 1149
Ø 1.00 - 14.00

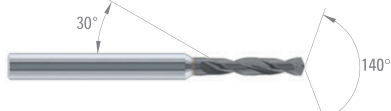

2	43	3 - 4 x Ø		✓		
---	----	-----------	--	---	--	--

DIXI 1147
Ø 0.50 - 10.00

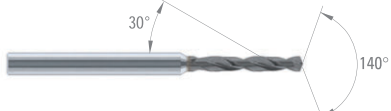

2	45	6.5 x Ø		✓		
---	----	---------	--	---	--	--

○ bien ⊙ excellent

Acier + Pb	Acier faibl. allié	Acier fort. allié	Acier inox aust.	Aciers Fontes 45-65 HRC	Fontes	Super alliages Ni / Co	Titane, alliages de titane	Alliage Cu Argent Or	Alliage Cu difficile	Alu	Graphite	Plastique
○	○	○	○		○		○	⊙	⊙	⊙		○

⊙	○	○	○		⊙	○	⊙	⊙	○	○	⊙	○
⊙	○	○	○		⊙	○	⊙	⊙	○	○	○	○
○	⊙	○	⊙		○	○	⊙	○	⊙	○		
○	⊙	○	⊙		○	○	⊙	○	⊙	○		
○	⊙	○	⊙		○	○	⊙	○	⊙	○		
○	⊙	○	⊙		○	○	⊙	○	⊙	○		
○	⊙	○	⊙		○	○	⊙	○	⊙	○		



○	○	⊙	⊙		⊙	○	⊙		○	○		
⊙	⊙	⊙	○		○	⊙	○			○		



SÉLECTION DES FORETS

✓ = article de stock

FORETS HÉLICOÏDAUX AUTO-CENTRANTS À TROUS DE LUBRIFICATION Z = 2

	Z	Page	L. coupe	CARBURE	TITAIN	XIDUR
DIXI 1145-HH Ø 0.70 - 14.00 	2	47	DIN 6537L 5 - 7 x Ø		✓	
DIXI 1146-HH Ø 0.80 - 10.00 	2	49	10 x Ø		✓	

FORETS HÉLICOÏDAUX ACIERS TREMPÉS > 45 HRC

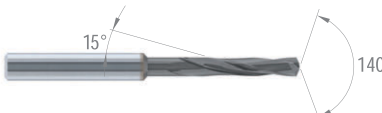
DIXI 1280 Ø 0.25 - 12.00 	2	51	3 - 7 x Ø			✓
-------------------------------------------------------------------------------------------------------------------------	---	----	-----------	--	--	---

FORETS HÉLICOÏDAUX Z = 3

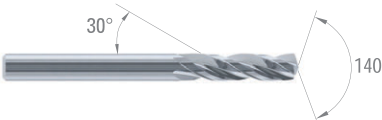
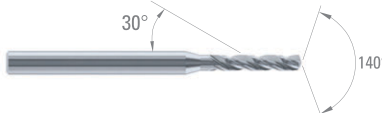
DIXI 1151 Ø 1.00 - 14.00 	3	53	3 - 8 x Ø	✓		
DIXI 1152 Ø 0.15 - 2.90 	3	55	6 - 10 x Ø	✓		

FORETS POUR MATIÈRES COMPOSITES / KEVLAR®

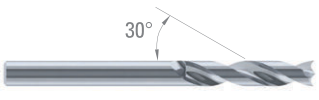
DIXI 1290 Ø 2.50 - 12.70 	2	57	3 - 7 x Ø	✓		
---------------------------------------------------------------------------------------------------------------------------	---	----	-----------	---	--	--

OUTILS SUR DEMANDE

FORETS PLATS

DIXI 1112 R+L Ø 0.08 - 5.99 	2	58				
------------------------------------------------------------------------------------------------------------------------------	---	----	--	--	--	--

MÈCHES À CANON DEMI-LUNE

DIXI 1114 R+L Ø 0.08 - 5.99 	1	58				
------------------------------------------------------------------------------------------------------------------------------	---	----	--	--	--	--

FORETS DENTURE DROITE

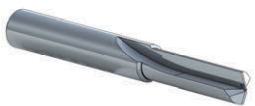
DIXI 1118 R+L Ø 0.08 - 5.99 	2	58				
------------------------------------------------------------------------------------------------------------------------------	---	----	--	--	--	--

SUR DEMANDE



○ bien ⊙ excellent

Acier + Pb	Acier faibl. allié	Acier fort. allié	Acier inox aust.	Aciers Fontes 45-65 HRC	Fontes	Super alliages Ni / Co	Titane, alliages de titane	Alliage Cu Argent Or	Alliage Cu difficile	Alu	Graphite	Plastique
------------	--------------------	-------------------	------------------	-------------------------	--------	------------------------	----------------------------	----------------------	----------------------	-----	----------	-----------

○	○	⊙	⊙		⊙	○	⊙		○	○		
⊙	⊙	⊙	○		○	⊙	○			○		

		○		⊙		○						
--	--	---	--	---	--	---	--	--	--	--	--	--

○	○				⊙		⊙	⊙		○		
○	○				⊙		⊙	⊙		○		

Kevlar®

												⊙
--	--	--	--	--	--	--	--	--	--	--	--	---

○					○			⊙	○	○		○
---	--	--	--	--	---	--	--	---	---	---	--	---





⊙								⊙	⊙	○		○
---	--	--	--	--	--	--	--	---	---	---	--	---

○					○			⊙	○	○		○
---	--	--	--	--	---	--	--	---	---	---	--	---

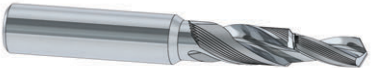

SÉLECTION DES FORETS

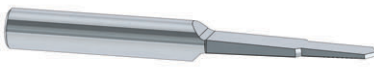
✓ = article de stock

FORETS ÉTAGÉS	Z	Page	L. coupe	<input type="checkbox"/> CARBURE					
DIXI 1501 R+L 		59							
DIXI 1502 R+L 		60							
DIXI 1503 R+L 		61							
DIXI 1504 R+L 		62			SUR DEMANDE				
DIXI 1512 		59 - 62							
DIXI 1514 		59 - 62							
DIXI 1518 		59 - 62							



○ bien ⊙ excellent

Acier + Pb	Acier faibl. allié	Acier fort. allié	Acier inox aust.	Aciers Fontes 45-65 HRC	Fontes	Super alliages Ni / Co	Titane, alliages de titane	Alliage Cu Argent Or	Alliage Cu difficile	Alu	Graphite	Plastique
⊙	○	○	○		○	○	○	⊙	○	⊙		○
⊙	○	○	○		○	○	○	⊙	○	⊙		○
⊙	○	○	○		○	○	○	⊙	○	⊙		○
⊙	○	○	○		○	○	○	⊙	○	⊙		○
○					○			⊙	○	○		○
⊙								⊙	⊙	○		○
○					○			⊙	○	○		○



DIXI 1101 60°

FORETS À CENTRER

Z = 2



P. 64



$D_1 \geq 3.15$



DIN 333 A

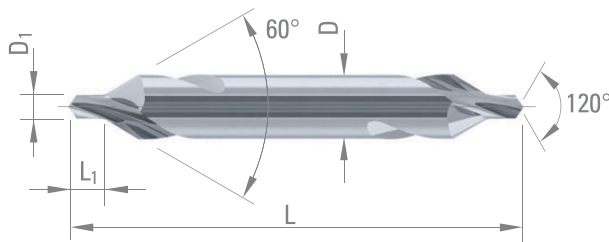

Acier + Pb	Acier faibl. allié	Acier fort. allié	Acier inox aust.	Fontes
Super alliages Ni / Co	Titane, alliage de titane	Alliage Cu Argent Or	Alliage Cu difficile	Alu
Plastique				

D_1	L_1	D_{h5}	L	CARBURE
0.80 $\begin{smallmatrix} +0.14 \\ 0 \end{smallmatrix}$	1.30 ± 0.1	3.15	31.50 ± 2	37253
1.00 $\begin{smallmatrix} +0.14 \\ 0 \end{smallmatrix}$	1.60 ± 0.2	3.15	31.50 ± 2	37254
1.25 $\begin{smallmatrix} +0.14 \\ 0 \end{smallmatrix}$	1.90 ± 0.2	3.15	31.50 ± 2	37255
1.60 $\begin{smallmatrix} +0.14 \\ 0 \end{smallmatrix}$	2.40 ± 0.2	4.00	35.50 ± 2	37256
2.00 $\begin{smallmatrix} +0.14 \\ 0 \end{smallmatrix}$	2.90 ± 0.2	5.00	40.00 ± 2	29156
2.50 $\begin{smallmatrix} +0.14 \\ 0 \end{smallmatrix}$	3.60 ± 0.2	6.30	45.00 ± 2	37257
3.15 $\begin{smallmatrix} +0.18 \\ 0 \end{smallmatrix}$	4.40 ± 0.3	8.00	50.00 ± 2	24756
4.00 $\begin{smallmatrix} +0.18 \\ 0 \end{smallmatrix}$	5.60 ± 0.4	10.00	56.00 ± 3	32950

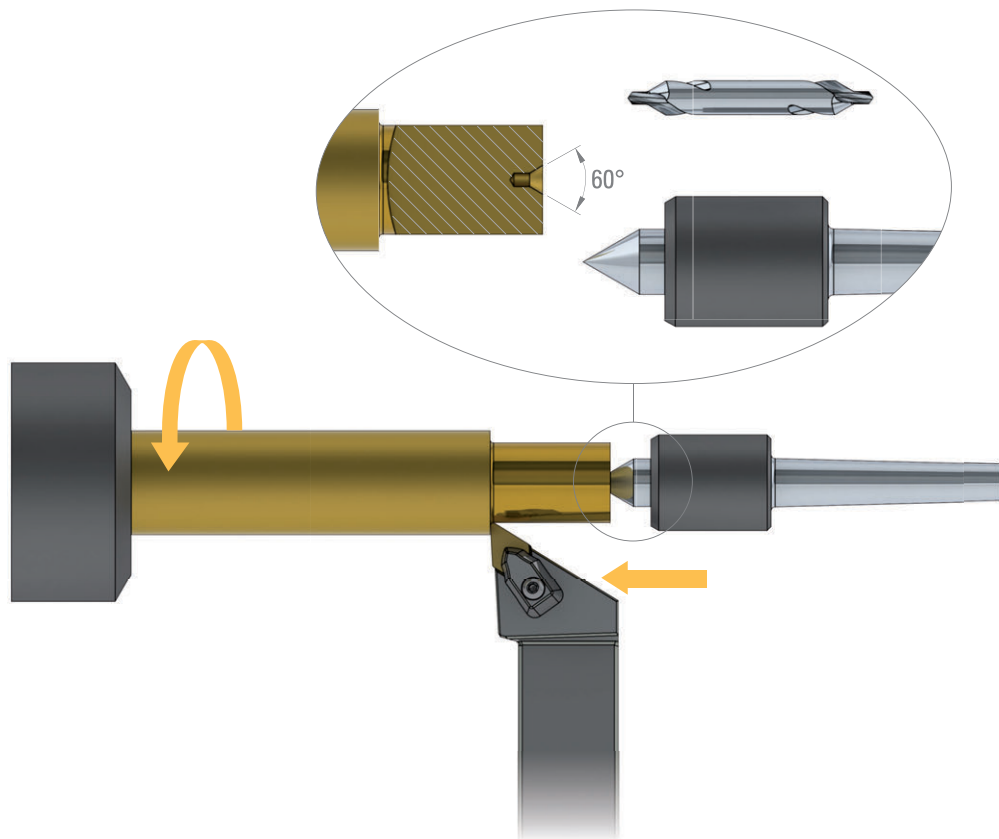

DIXI 1106 90°

FORETS À POINTER NC

Z = 2



P. 64

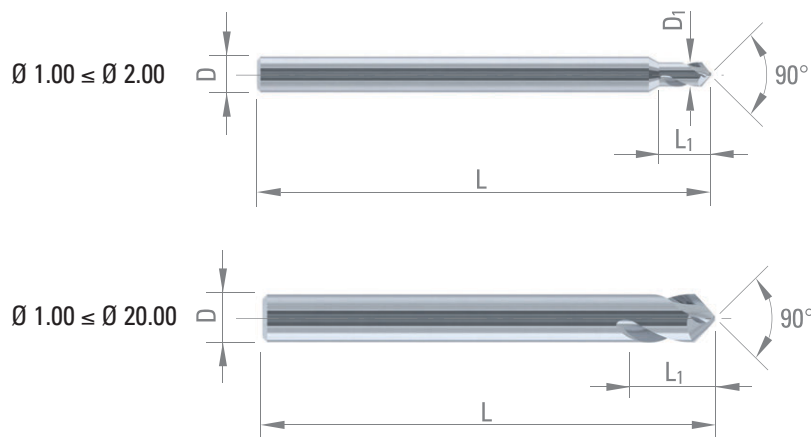

- Acier + Pb
- Acier faibl. allié
- Acier fort. allié
- Acier inox aust.
- Fontes
- Super alliages Ni / Co
- Titane, alliage de titane
- Alliage Cu Argent Or
- Alliage Cu difficile
- Alu
- Plastique

D _{1h6}	L ₁	D _{h5}	L	CARBURE	TiAIN
1.00	3	3	38	956799	957230
1.50	5	3	38	956800	957231
2.00	5	3	38	956801	957232



D _{h5}	L ₁	L	CARBURE	TiAIN
1.00	3	32	953781	953780
1.50	5	32	953778	953779
2.00	5	32	47101	62892
3.00	9	38	43231	34090
4.00	10	50	36911	61280
5.00	13	50	47716	63736
* 6.00	13	57	42788	63757
* 8.00	27	63	42789	63758
* 10.00	30	72	43233	61561
* 12.00	35	83	43064	41463
* 16.00	46	92	43234	63759
* 20.00	52	104	43235	63760



* = affûtage logarithmique

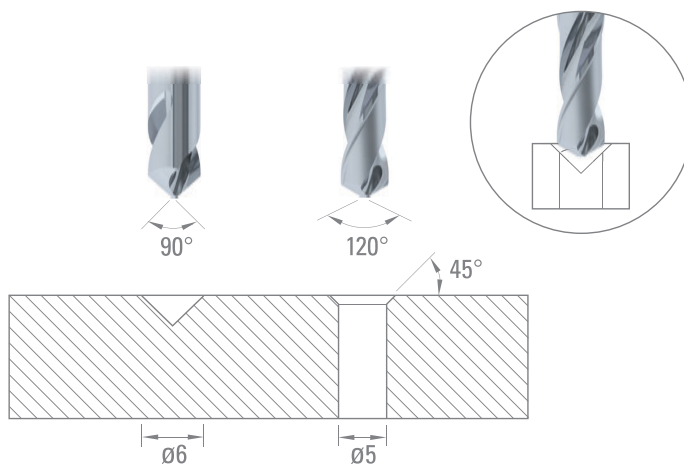

DIXI 1106 L 90°

FORETS À POINTER NC
À GAUCHE

Z = 2



P. 64

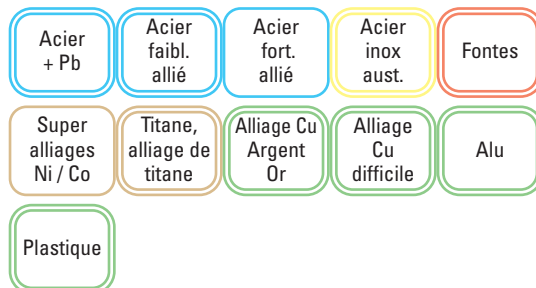
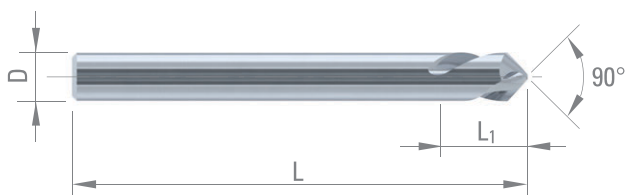

D _{h5}	L ₁	L	CARBURE
4.00	10	50	47714
5.00	13	50	47715
6.00	13	57	48813

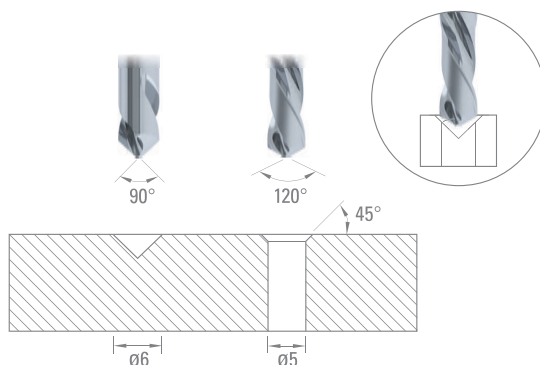

DIXI 1107 120°

FORETS À POINTER NC

Z = 2



P. 64

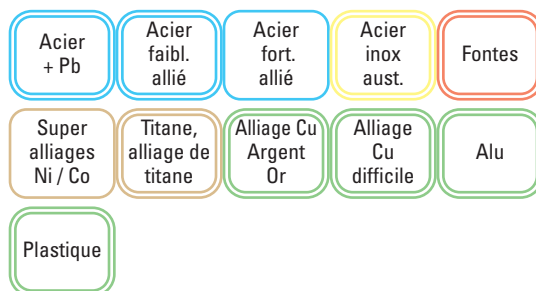
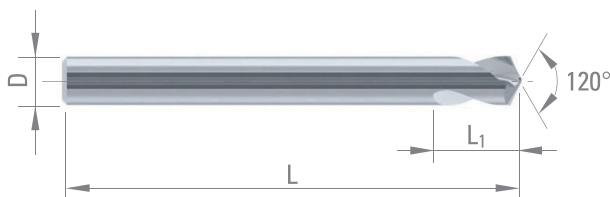

D _{h5}	L ₁	L	CARBURE
1.00	3	38	985118
2.00	5	38	985120
3.00	9	38	43236
4.00	10	50	36914
6.00	13	57	43238
* 8.00	27	63	43239
* 10.00	30	72	43240
* 12.00	35	83	43241
* 16.00	46	92	43242
* 20.00	52	104	43243

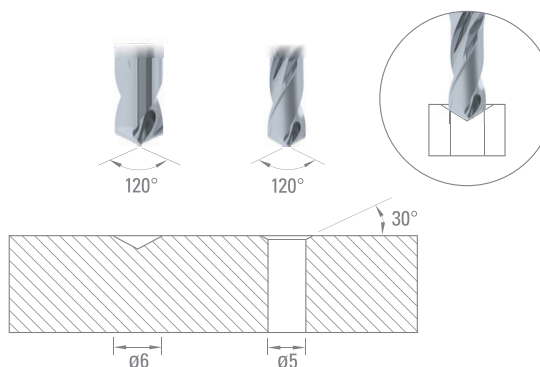

* = affûtage logarithmique



DIXI 1108 90°

FORETS À POINTER CORPS RENFORCÉ

Z = 2



P. 64

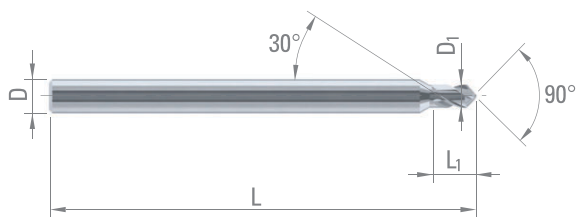

Acier + Pb	Acier faibl. allié	Acier fort. allié	Acier inox aust.	Fontes
Super alliages Ni / Co	Titane, alliage de titane	Alliage Cu Argent Or	Alliage Cu difficile	Alu
Plastique				

D _{1 h6}	L ₁	D _{h5}	L	CARBURE	TiAlN
0.50	1.0	3	38	983702	
0.60	1.0	3	38	964801	
0.65	1.0	3	38	964800	
0.70	1.0	3	38	964799	
0.75	1.0	3	38	964798	
0.80	1.5	3	38	956678	956679
0.82	1.5	3	38	956681	956682
0.85	1.5	3	38	956684	956685
0.87	1.5	3	38	956687	956689
0.90	1.5	3	38	956691	956693
0.92	1.5	3	38	956695	956696
0.95	1.5	3	38	956697	956703
0.97	1.5	3	38	956704	956706
1.00	1.5	3	38	956708	956707
1.02	2.0	3	38	956709	956710
1.05	2.0	3	38	956711	956712
1.07	2.0	3	38	956713	956714
1.10	2.0	3	38	956715	956716
1.12	2.0	3	38	956717	956718
1.15	2.0	3	38	956719	956720
1.17	2.0	3	38	956721	956722
1.20	2.0	3	38	956723	956724
1.22	2.0	3	38	956725	956726
1.25	2.0	3	38	956727	956728
1.27	2.0	3	38	956729	956730
1.30	2.0	3	38	956731	956732
1.32	2.0	3	38	956733	956734
1.35	2.0	3	38	956735	956736
1.37	2.0	3	38	956737	956738
1.40	2.0	3	38	956739	956740
1.42	2.0	3	38	956741	956742
1.45	2.0	3	38	956743	956744
1.47	2.0	3	38	956745	956746
1.50	2.0	3	38	956747	956748
1.52	3.0	3	38	956749	956750
1.55	3.0	3	38	956751	956752
1.57	3.0	3	38	956753	956754
1.60	3.0	3	38	956755	956756
1.62	3.0	3	38	956757	956758
1.65	3.0	3	38	956759	956760
1.67	3.0	3	38	956761	956762

D _{1 h6}	L ₁	D _{h5}	L	CARBURE	TiAlN
1.70	3.0	3	38	956763	956764
1.72	3.0	3	38	956765	956766
1.75	3.0	3	38	956767	956768
1.77	3.0	3	38	956769	956770
1.80	3.0	3	38	956771	956772
1.82	3.0	3	38	956773	956774
1.85	3.0	3	38	956775	956776
1.87	3.0	3	38	956777	956778
1.90	3.0	3	38	956779	956780
1.92	3.0	3	38	956781	956782
1.95	3.0	3	38	956783	956784
1.97	3.0	3	38	956785	956786
2.00	3.0	3	38	956803	956804
2.10	3.0	3	38	956812	956813
2.20	3.0	3	38	956820	956821
2.30	3.0	3	38	956828	956830
2.40	3.0	3	38	956837	956838
2.50	3.0	3	38	956845	956846



DIXI 1109 120°

FORETS À POINTER CORPS RENFORCÉ

Z = 2



P. 64

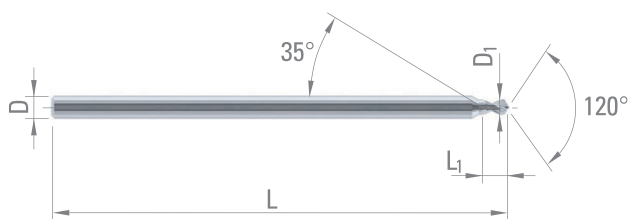

Acier + Pb	Acier faibl. allié	Acier fort. allié	Acier inox aust.	Fontes
Super alliages Ni / Co	Titane, alliage de titane	Alliage Cu Argent Or	Alliage Cu difficile	Alu
Plastique				

$D_{10/-0.004}$	L_1	D_{h5}	L	CARBURE	DICUT
0.50	1.0	1.5	30	62674	67354
0.55	1.0	1.5	30	62675	67355
0.60	1.2	1.5	30	62676	67356
0.65	1.2	1.5	30	62677	67357
0.70	1.5	1.5	30	62678	67358
0.75	1.5	1.5	30	62679	67359
0.80	2.0	1.5	30	52126	60989
0.85	2.0	1.5	30	52127	67360
0.90	2.0	1.5	30	52128	60990
0.95	2.0	1.5	30	52129	67361
1.00	2.0	1.5	30	52130	60991
1.05	2.0	1.5	30	52131	67362
1.10	2.0	1.5	30	52132	60992
1.15	2.4	1.5	30	52133	62487
1.20	2.4	1.5	30	52134	60993
1.25	2.4	1.5	30	52135	67363
1.30	2.4	1.5	30	52136	60994
1.35	2.4	1.5	30	52137	67364
1.40	2.4	1.5	30	52138	63485
1.45	2.4	1.5	30	52139	67365
1.50	3.0	2.0	32	981825	981839
1.55	3.0	2.0	32	981826	981840
1.60	3.0	2.0	32	981827	981841
1.65	3.0	2.0	32	981828	981842
1.70	3.0	2.0	32	981829	981843
1.75	3.5	2.0	32	981830	981844
1.80	3.5	2.0	32	981831	981845
1.85	3.5	2.0	32	981832	981847
1.90	3.5	2.0	32	981833	981848
1.95	3.5	2.0	32	981834	981849
2.00	4.0	2.5	32	981317	981325
2.10	4.0	2.5	32	981835	981850
2.20	4.0	2.5	32	981836	981852
2.30	4.0	2.5	32	981837	981853
2.40	4.0	2.5	32	981838	981854
2.50	4.0	2.5	32	981320	981327

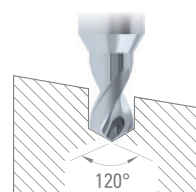
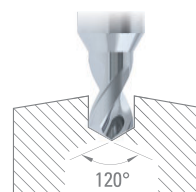
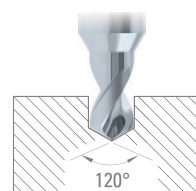

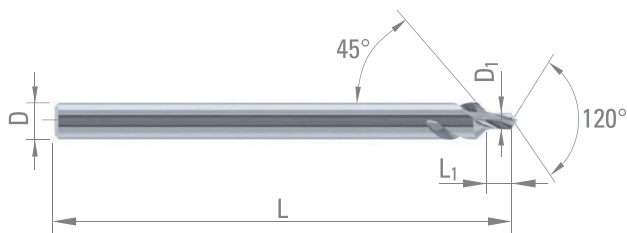

- Acier + Pb
- Acier faibl. allié
- Acier fort. allié
- Acier inox aust.
- Fontes
- Super alliages Ni / Co
- Titane, alliage de titane
- Alliage Cu Argent Or
- Alliage Cu difficile
- Alu
- Plastique

$D_{10/-0.004}$	L_1	D_{h5}	L	CARBURE	TiAIN
0.80	2.0	3	38	60268	64055
0.85	2.0	3	38	60269	67239
0.90	2.0	3	38	60270	64000
0.95	2.0	3	38	60271	67240
1.00	2.0	3	38	60272	64056
1.05	2.0	3	38	60273	67241
1.10	2.0	3	38	60274	63523
1.15	2.4	3	38	60275	67242
1.20	2.4	3	38	60276	64001
1.25	2.4	3	38	60277	67243
1.30	2.4	3	38	60278	67244
1.35	2.4	3	38	60279	67245
1.40	2.4	3	38	60280	64002
1.45	2.4	3	38	60281	67246

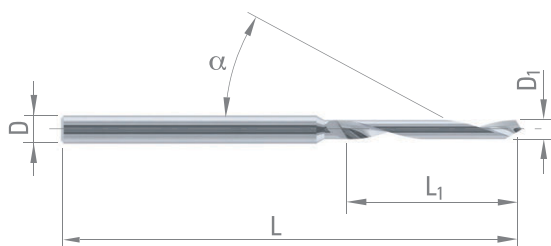

Acier
+ PbAlliage Cu
Argent
OrAlliage
Cu
difficile

$D_{10/-0.004}$	L_1	D_{h5}	L	CARBURE
0.10	0.7	1.0	30	955371
0.15	1.0	1.0	30	955374
0.20	1.0	1.0	30	955375
0.25	1.0	1.0	30	955377
0.30	1.5	1.0	30	955378
0.35	1.5	1.0	30	955379
0.40	2.0	1.0	30	955380
0.45	3.6	1.0	30	955381
0.50	4.0	1.0	30	955382
0.55	4.5	1.0	30	955383
0.60	4.5	1.0	30	955384
0.65	5.0	1.0	30	955385
0.70	5.6	1.0	30	955386
0.75	5.6	1.0	30	955387
0.80	6.3	1.5	30	955388
0.85	6.3	1.5	30	955389
0.90	7.1	1.5	30	955390
0.95	7.1	1.5	30	955391
1.00	9.0	1.5	30	955392
1.05	9.0	1.5	30	955393
1.10	9.0	1.5	30	955394
1.15	9.0	1.5	30	955395
1.20	10.0	1.5	30	955396
1.30	10.0	1.5	30	965839
1.40	11.2	1.5	30	965840
1.45	11.2	1.5	30	965841
1.50	12.0	2.0	38	961881
1.60	12.0	2.0	38	965842
1.65	12.0	2.0	38	965843
1.70	12.0	2.0	38	961882
1.75	12.0	2.0	38	965844
1.80	12.0	2.0	38	961883
2.00	12.0	2.5	43	959038

 $D_1 \pm 1 \mu\text{m}$ sur demande**Autres diamètres jusqu'à $\varnothing 5.99$ sur demande**

DIXI 1126

FORETS HÉLICOÏDAUX

Z = 2



P. 63



P. 68



D₁ ≥ 3.1

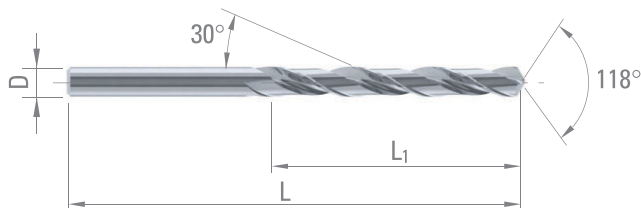

Acier + Pb	Acier faibl. allié	Acier fort. allié	Acier inox aust.	Fontes
Super alliages Ni / Co	Titane, alliage de titane	Alliage Cu Argent Or	Alliage Cu difficile	Alu
Graphite	Plastique			

D _{h5}	L ₁	L	CARBURE DICUT	
1.00	12	34	40244	53697
1.10	14	36	40656	53698
1.20	16	38	40657	53699
1.30	16	38	40658	53700
1.40	18	40	40659	53701
1.50	18	40	40077	53702
1.60	20	43	40703	53703
1.70	20	43	38677	53704
1.80	22	46	41510	53705
1.90	22	46	41370	53706
2.00	24	49	41593	53707
2.10	24	49	40707	53708
2.20	27	53	40125	53709
2.30	27	53	43515	53710
2.40	30	57	45074	53711
2.50	30	57	40978	53712
2.60	30	57	40607	53713
2.70	33	61	41318	53714
2.80	33	61	41024	54284
2.90	33	61	40608	53715
3.00	33	61	40059	53716
3.10	36	65	40173	53717
3.20	36	65	41511	53718
3.30	36	65	40575	53736
3.40	39	70	41247	53737
3.50	39	70	41451	53738
3.60	39	70	40078	53739
3.70	39	70	40174	53740
3.80	43	75	40060	53741
3.90	43	75	43676	53742
4.00	43	75	43497	53743
4.10	43	75	41218	53744
4.20	43	75	41295	53745
4.30	47	80	41452	53746
4.40	47	80	42866	53747
4.50	47	80	40263	53748
4.60	47	80	41991	53749
4.70	47	80	34710	53750
4.80	52	86	40126	53751
4.90	52	86	42661	53752

D _{h5}	L ₁	L	CARBURE DICUT	
5.00	52	86	40061	53753
5.10	52	86	42022	53754
5.20	52	86	40062	53755
5.30	52	86	40063	53756
5.40	57	93	40064	53757
5.50	57	93	40065	53758
5.60	57	93	41992	53759
5.70	57	93	43357	53760
5.80	57	93	40864	53761
5.90	57	93	40258	53762
6.00	57	93	39996	53763
6.10	63	101	40704	54264
6.20	63	101	40066	54267
6.30	63	101	40067	54283
6.40	63	101	40068	54287
6.50	63	101	40069	54290
6.60	63	101	40070	54293
6.70	63	101	40071	54304
6.80	69	109	40943	54306
6.90	69	109	41512	54309
7.00	69	109	40072	54312
7.50	69	109	40912	54315
7.70	75	117	53196	54318
7.80	75	117	45792	54321
8.00	75	117	40073	54324
8.50	75	117	40074	54811
9.00	81	125	40075	54778
9.50	81	125	41641	54781
10.00	87	133	40812	54784
10.20	87	133	40944	54787
10.50	87	133	34732	54790
11.00	94	142	40127	54793
11.50	94	142	40865	54795
12.00	101	151	41513	54798
12.50	101	151	41642	54801
13.00	101	151	40660	54804
13.50	108	160	40076	54807
14.00	108	160	40771	54810



DIXI 1130

FORETS HÉLICOÏDAUX

Z = 2



P. 63



P. 70



D₁ ≥ 3.1



DIN
6539

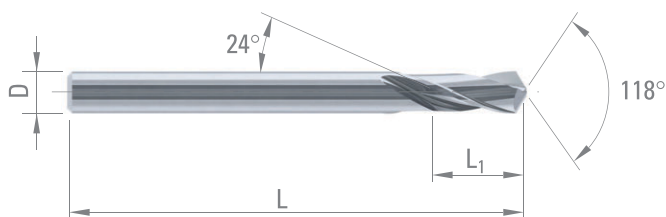

Acier + Pb	Acier faibl. allié	Acier fort. allié	Fontes	Titane, alliage de titane
Alliage Cu Argent Or	Alliage Cu difficile	Alu	Graphite	Plastique

D _{h5}	L ₁	L	CARBURE DICUT	
0.30	5	30	24828	953165
0.35	5	30	37861	953167
0.40	6	30	244	953169
0.45	6	30	245	953171
0.50	6	30	246	54480
0.55	6	30	247	54481
0.60	6	30	248	54482
0.65	6	30	249	54483
0.70	6	30	250	54484
0.75	6	30	251	54485
0.80	7	30	252	54487
0.85	7	30	253	54486
0.90	7	30	254	54528
0.95	7	30	255	54488
1.00	7	30	256	54490
1.05	8	30	257	54491
1.10	8	30	258	54492
1.15	8	30	259	54493
1.20	8	30	260	54494
1.25	8	30	261	54495
1.30	8	30	262	54496
1.35	8	30	263	54497
1.40	8	30	264	54498
1.45	8	30	265	54499
1.50	8	30	266	54500
1.55	9	38	267	54501
1.60	9	38	268	54502
1.65	9	38	269	54503
1.70	9	38	270	54504
1.75	9	38	271	54505
1.80	9	38	272	54506
1.85	9	38	32277	54507
1.90	9	38	274	54509
1.95	9	38	275	54508
2.00	9	38	276	54510
2.05	9	38	39575	54511
2.10	9	38	39757	54512
2.15	10	40	33192	54513
2.20	10	40	39655	54514

D _{h5}	L ₁	L	CARBURE DICUT	
2.25	10	40	4562	54516
2.30	10	40	43350	54529
2.35	10	40	1756	54530
2.40	11	43	42869	54531
2.45	11	43	4563	54532
2.50	11	43	43351	54533
2.55	11	43	41514	54534
2.60	11	43	41874	54535
2.65	11	43	4564	54536
2.70	12	46	42139	54539
2.75	12	46	4565	54537
2.80	12	46	42339	54538
2.85	12	46	42522	54540
2.90	12	46	41911	54541
2.95	12	46	41501	54542
3.00	12	46	41840	54543
3.05	14	49	4607	54544
3.10	14	49	41456	54545
3.15	14	49	1757	54546
3.20	14	49	42023	54547
3.25	14	49	3356	54548
3.30	14	49	290	54549
3.35	14	49	4567	54550
3.40	15	52	42200	54551
3.45	15	52	4020	54552
3.50	15	52	41534	54553
3.55	15	52	4568	54554
3.60	15	52	41535	54556
3.65	15	52	42523	54557
3.70	15	52	43037	54558
3.75	15	52	4570	54560
3.80	17	55	4610	54562
3.85	17	55	4571	54563
3.90	17	55	4142	54565
3.95	17	55	42870	54567
4.00	17	55	42093	54568
4.05	17	55	42871	54569
4.10	17	55	42652	54570
4.15	17	55	15177	54571



DIXI 1130



P. 63



P. 70



$D_1 \geq 3.1$



DIN
6539

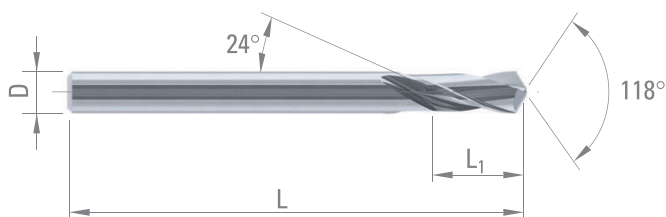

Acier + Pb	Acier faibl. allié	Acier fort. allié	Fontes	Titane, alliage de titane
Alliage Cu Argent Or	Alliage Cu difficile	Alu	Graphite	Plastique

D_{h5}	L_1	L	CARBURE DICUT	
4.20	17	55	42340	54572
4.25	17	55	39938	54573
4.30	18	58	301	54574
4.35	18	58	39939	54575
4.40	18	58	29689	54576
4.45	18	58	4616	54577
4.50	18	58	303	54578
4.55	18	58	40790	54579
4.60	18	58	39013	54580
4.65	18	58	19790	54581
4.70	18	58	42170	54582
4.75	18	58	40791	54583
4.80	20	62	29756	54584
4.85	20	62	42524	54585
4.90	20	62	41914	54586
4.95	20	62	39997	54587
5.00	20	62	29758	54588
5.10	20	62	29759	54589
5.20	20	62	29760	54590
5.30	20	62	29761	54593
5.40	21	66	29693	54594
5.50	21	66	29694	54595
5.60	21	66	41594	54596
5.70	21	66	45724	54597
5.80	21	66	316	54599
5.90	21	66	28594	54600
6.00	21	66	42173	54601
6.10	23	70	29762	54602
6.20	23	70	41457	54618
6.30	23	70	29764	54619
6.40	23	70	42171	54620
6.50	23	70	42220	54621
6.60	23	70	41515	54622
6.70	23	70	41680	54623
6.80	25	74	326	54624
6.90	25	74	327	54625
7.00	25	74	328	54626
7.10	25	74	8646	54627
7.20	25	74	50671	54628

D_{h5}	L_1	L	CARBURE DICUT	
7.30	25	74	53054	54629
7.50	25	74	5389	54631
7.60	27	79	53056	54632
7.70	27	79	22351	54633
7.80	27	79	50331	54634
7.90	27	79	53057	54635
8.00	27	79	42821	54636
8.10	27	79	53058	54639
8.20	27	79	25291	54640
8.30	27	79	53479	54641
8.40	27	79	53059	54642
8.50	27	79	42653	54643
8.80	29	84	57852	59399
9.00	29	84	35325	54644
9.20	29	84	57851	59401
9.50	29	84	39660	54645
9.80	31	89	57853	963531
10.00	31	89	7958	54646
10.20	31	89	34340	54647
10.50	31	89	30130	54648
11.00	33	95	28591	54649
11.50	33	95	41092	54650
12.00	35	102	14939	54651
13.00	35	102	21462	54653
13.50	37	107	45725	54654
14.00	37	107	23729	54655



DIXI 1130 L

FORETS HÉLICOÏDAUX À GAUCHE

Z = 2



P. 63



P. 70



$D_1 \geq 3.1$

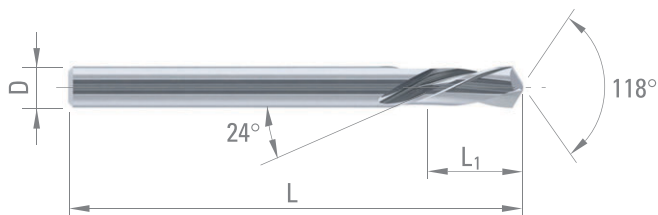

Acier + Pb	Acier faibl. allié	Acier fort. allié	Fontes	Titane, alliage de titane
Alliage Cu Argent Or	Alliage Cu difficile	Alu	Graphite	Plastique

D_{h5}	L_1	L	CARBURE DICUT	
0.30	5	30	37906	953748
0.35	5	30	37907	953752
0.40	6	30	330	953754
0.45	6	30	331	953758
0.50	6	30	332	54659
0.55	6	30	333	54660
0.60	6	30	334	54661
0.65	6	30	335	54662
0.70	6	30	336	54663
0.75	6	30	37908	54664
0.80	8	30	338	54665
0.85	8	30	339	54666
0.90	8	30	340	54667
0.95	8	30	341	54668
1.00	8	30	29560	54669
1.05	10	30	343	54670
1.10	10	30	344	54671
1.15	10	30	345	54672
1.20	10	30	346	54673
1.25	10	30	347	54674
1.30	10	30	348	54675
1.35	10	30	349	54676
1.40	10	30	350	54677
1.45	10	30	351	54678
1.50	10	30	352	54679
1.55	16	38	38634	54680
1.60	16	38	38826	54681
1.65	16	38	39127	54682
1.70	16	38	39126	54683
1.75	16	38	38827	54684
1.80	16	38	395	54685
1.85	16	38	38921	54686
1.90	16	38	30637	54687
1.95	16	38	38997	54688
2.00	16	38	35181	54689
2.05	16	38	27526	54690
2.10	16	38	39657	54691
2.15	16	40	39041	54692
2.20	16	40	38965	54693

D_{h5}	L_1	L	CARBURE DICUT	
2.25	16	40	40245	54694
2.30	16	40	38769	54695
2.35	16	40	26575	54696
2.40	16	43	23429	54698
2.45	16	43	45720	54699
2.50	16	43	43245	54700
2.55	16	43	41034	54701
2.60	16	43	39043	54702
2.65	16	43	4026	54703
2.70	16	46	40247	54704
2.75	16	46	43036	54705
2.80	16	46	370	54706
2.85	16	46	40266	54707
2.90	16	46	40793	54708
2.95	16	46	40511	54709
3.00	16	46	42787	54710
3.05	18	49	40079	54711
3.10	18	49	40661	54712
3.15	18	49	40794	54713
3.20	18	49	40267	54714
3.25	18	49	40080	54715
3.30	18	49	375	54716
3.35	18	49	40296	54717
3.40	20	50	376	54718
3.45	20	50	37957	54719
3.50	20	50	377	54720
3.55	20	50	41596	54721
3.60	20	50	40662	54722
3.65	20	50	40797	54723
3.70	20	50	379	54724
3.75	20	50	38922	54725
3.80	22	50	40172	54726
3.85	22	50	37960	54727
3.90	22	50	38923	54728
3.95	22	50	37962	54729
4.00	22	50	382	54730
4.05	22	50	40801	54731
4.10	22	50	383	54732
4.15	22	50	40576	54733



DIXI 1130 L



P. 63



P. 70



$D_1 \geq 3.1$

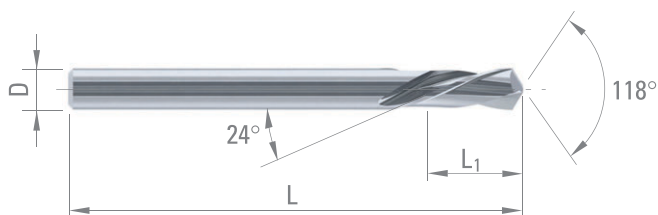

Acier + Pb	Acier faibl. allié	Acier fort. allié	Fontes	Titane, alliage de titane
Alliage Cu Argent Or	Alliage Cu difficile	Alu	Graphite	Plastique

D_{h5}	L_1	L	CARBURE DICUT	
4.20	22	50	384	54734
4.25	22	50	39658	54735
4.30	24	50	385	54736
4.35	24	50	37966	54737
4.40	24	50	37967	54738
4.45	24	50	27518	54739
4.50	24	50	387	54740
4.55	24	50	37968	54741
4.60	24	50	388	54742
4.75	24	50	37970	54745
4.80	25	50	390	54746
4.85	25	50	37971	54747
4.90	25	50		54748
4.95	25	50	37972	54749
5.00	25	50	392	54750
5.20	25	50	4141	
5.50	25	50	27042	54755
5.60	25	50	27041	54756
5.70	25	50	37981	54757
5.90	25	50	6489	54759
6.00	28	66	43390	54760
6.10	31	70	43915	54761
6.40	31	70	45723	54764
6.50	31	70	37994	54765
6.60	31	70	37996	54766
6.70	31	70	45721	54767
6.90	34	74	43847	
7.50	34	74	38021	54771





P. 63



P. 74

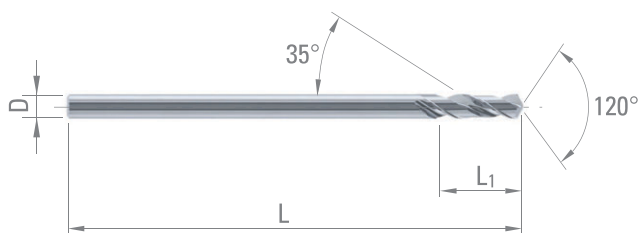

Acier + Pb	Acier faibl. allié	Acier fort. allié	Acier inox aust.	Fontes
Super alliages Ni / Co	Titane, alliage de titane	Alliage Cu Argent Or	Alliage Cu difficile	Alu
Graphite	Plastique			

D _{h5}	L ₁	L	CARBURE	DICUT
0.40	6	30	197	953186
0.45	6	30	198	58925
0.50	6	30	199	53585
0.55	6	30	200	53586
0.60	6	30	201	53582
0.65	6	30	202	53588
0.70	6	30	203	53589
0.75	6	30	204	53587
0.80	7	30	205	53590
0.85	7	30	206	53591
0.90	7	30	207	53592
0.95	7	30	208	53593
1.00	7	30	40275	53583
1.05	8	30	210	53594
1.10	8	30	41502	53595
1.15	8	30	212	53596
1.20	8	30	41150	53597
1.25	8	30	41319	53598
1.30	8	30	215	53599
1.35	8	30	41320	53600
1.40	8	30	217	53584
1.45	8	30	218	53601
1.50	8	30	219	53602
1.55	9	38	220	53604
1.60	9	38	221	53605
1.65	9	38	5418	53606
1.70	9	38	222	53607
1.75	9	38	42537	53608
1.80	9	38	223	53609
1.85	9	38	42538	53610
1.90	9	38	224	53611
1.95	9	38	42539	53612
2.00	9	38	225	53613





P. 63



P. 76



D₁ ≥ 3.1

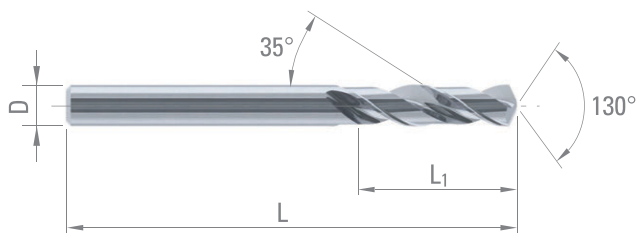

Acier + Pb	Acier faibl. allié	Acier fort. allié	Acier inox aust.	Fontes
Titane, alliage de titane	Alliage Cu Argent Or	Alliage Cu difficile	Alu	Plastique

D _{h5}	L ₁	L	CARBURE DICUT	
0.50	9	38	91	57557
0.55	9	38	92	57558
0.60	13	38	93	57559
0.65	13	38	94	57560
0.70	13	38	95	55471
0.75	13	38	96	55473
0.80	13	38	97	55475
0.85	13	38	98	55482
0.90	16	38	99	55599
0.95	16	38	100	55601
1.00	16	38	101	55603
1.05	16	38	102	55605
1.10	16	38	103	55607
1.15	16	38	104	55609
1.20	16	38	105	55611
1.25	16	38	106	55613
1.30	16	38	107	55615
1.35	16	38	108	55617
1.40	16	38	109	55619
1.45	16	38	110	55621
1.50	16	38	111	55623
1.55	16	38	2972	55625
1.60	16	38	112	55627
1.65	16	38	3360	55629
1.70	16	38	113	55631
1.75	16	38	3361	55633
1.80	16	38	114	55635
1.85	16	38	115	55637
1.90	16	38	116	55639
1.95	16	38	3362	55641
2.00	16	38	117	55643
2.10	16	38	118	55645
2.20	16	40	119	55647
2.30	16	40	120	55649
2.40	16	43	121	55651
2.50	16	43	122	55653
2.60	16	43	35575	55655

D _{h5}	L ₁	L	CARBURE DICUT	
3.00	16	46	35726	55657
3.30	18	49	35665	55659
3.50	20	50	35727	55661
4.00	22	55	34062	55663
4.20	22	55	35728	55665
4.50	24	58	35729	55667
5.00	26	62	35730	55669
5.50	28	66	45735	55671
6.00	28	66	45736	55673



DIXI 1131

FORETS HÉLICOÏDAUX CORPS RENFORCÉ

Z = 2



P. 63



P. 72

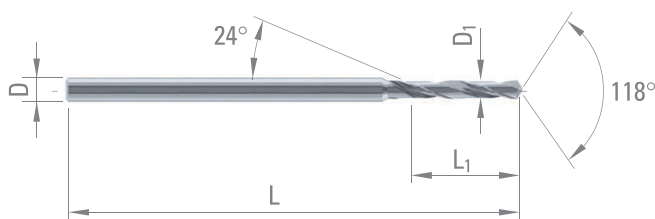

Acier + Pb	Acier faibl. allié	Acier fort. allié	Acier inox aust.	Fontes
Super alliages Ni / Co	Titane, alliage de titane	Alliage Cu Argent Or	Alliage Cu difficile	Alu
Graphite	Plastique			

D _{1 0/-0.004}	L ₁	D _{h5}	L	CARBURE DICUT	DLC*	
0.05	0.35	1.0	30	962703		
0.06	0.4	1.0	30	962702		
0.07	0.5	1.0	30	962701		
0.08	0.6	1.0	30	962700		
0.09	0.65	1.0	30	962699		
0.10	0.7	1.0	30	36792		
0.11	0.7	1.0	30	40829		
0.12	0.7	1.0	30	40627		
0.13	0.7	1.0	30	40628		
0.14	0.7	1.0	30	40629		
0.15	1.0	1.0	30	35600		
0.16	1.0	1.0	30	38658		
0.17	1.0	1.0	30	38659		
0.18	1.0	1.0	30	38660		
0.19	1.0	1.0	30	38661		
0.20	1.0	1.0	30	26824	952580	955953
0.21	1.0	1.0	30	29609	952581	955954
0.22	1.0	1.0	30	29610	952582	955955
0.23	1.0	1.0	30	29611	950087	955956
0.23 >	2.2	1.0	30	62513	952583	962712
0.24	1.0	1.0	30	25957	952496	955957
0.24 >	2.2	1.0	30	62514	952584	962713
0.25	1.0	1.0	30	28712	950088	955958
0.25 >	2.2	1.0	30	38282	952585	962714
0.26	1.0	1.0	30	38665	952587	955959
0.27	1.0	1.0	30	37358	952588	955960
0.28	1.0	1.0	30	37258	952589	955961
0.29	1.0	1.0	30	30568	952590	955962
0.30	1.5	1.0	30	28713	952591	955963
0.31	1.5	1.0	30	35421	952592	955964
0.32	1.5	1.0	30	38662	952593	955965
0.32 >	3.0	1.0	30	62515	952594	962715
0.33	1.5	1.0	30	38663	952595	955966
0.33 >	3.0	1.0	30	62516	952596	962716
0.34	1.5	1.0	30	29570	952597	955967
0.34 >	3.0	1.0	30	62517	952598	962717
0.35	1.5	1.0	30	31747	952599	955968
0.36	1.5	1.0	30	39018	952600	955970
0.37	1.5	1.0	30	40633	952601	955971
0.38	1.5	1.0	30	40634	952602	955972
0.39	1.5	1.0	30	40635	952603	955973

D _{1 0/-0.004}	L ₁	D _{h5}	L	CARBURE DICUT	DLC*	
0.40	2.0	1.0	30	25992	63706	955974
0.41	2.0	1.0	30	29571	952604	955975
0.42	2.0	1.0	30	38419	952605	955976
0.43	2.0	1.0	30	35804	950186	955977
0.44	2.0	1.0	30	40636	952606	955978
0.45	3.6	1.0	30	45726	59562	955979
0.46	3.6	1.0	30	45727	952607	955980
0.47	3.6	1.0	30	45728	952497	955981
0.48	3.6	1.0	30	45729	952608	955982
0.49	4.0	1.0	30	45730	952609	955983
0.50	4.0	1.0	30	25994	55141	955984
0.51	4.0	1.0	30	45731	55142	955985
0.52	4.0	1.0	30	45732	55143	955986
0.53	4.0	1.0	30	45733	55144	955987
0.54	4.5	1.0	30	40640	55145	955988
0.55	4.5	1.0	30	28375	55146	955989
0.56	4.5	1.0	30	41925	55147	955990
0.57	4.5	1.0	30	40641	55148	955991
0.58	4.5	1.0	30	40642	55149	955993
0.59	4.5	1.0	30	40643	55150	955997
0.60	4.5	1.0	30	29643	55151	956048
0.61	5.0	1.0	30	37639	55152	956049
0.62	5.0	1.0	30	25270	55153	956050
0.63	5.0	1.0	30	40644	55154	956051
0.64	5.0	1.0	30	40645	55155	956052
0.65	5.0	1.0	30	41679	55156	956053
0.66	5.0	1.0	30	41886	55157	956054
0.67	5.0	1.0	30	42286	55158	956055
0.68	5.6	1.0	30	42287	55159	956056
0.69	5.6	1.0	30	41788	55160	956057
0.70	5.6	1.0	30	32099	55161	956058
0.71	5.6	1.0	30	42288	55162	956059
0.72	5.6	1.0	30	40983	55163	956060
0.73	5.6	1.0	30	35422	55164	956061
0.74	5.6	1.0	30	36102	55165	956062
0.75	5.6	1.0	30	35423	55166	956063
0.76	6.3	1.0	30	18579	55167	956064
0.77	6.3	1.0	30	42706	55168	956065
0.78	6.3	1.0	30	41887	55169	956066
0.79	6.3	1.0	30	36640	55170	956068

* pour matériaux non-ferreux





P. 63



P. 72

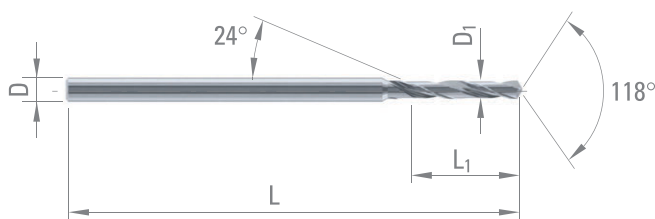

Acier + Pb	Acier faibl. allié	Acier fort. allié	Acier inox aust.	Fontes
Super alliages Ni / Co	Titane, alliage de titane	Alliage Cu Argent Or	Alliage Cu difficile	Alu
Graphite	Plastique			

D _{1 0/-0.004}	L ₁	D _{h5}	L	CARBURE	DICUT	DLC*
0.80	6.3	1.5	30	402	55171	956069
0.81	6.3	1.5	30	36144	55172	956070
0.82	6.3	1.5	30	34510	55173	956071
0.83	6.3	1.5	30	42290	55174	956072
0.84	6.3	1.5	30	27400	55175	956074
0.85	6.3	1.5	30	35551	55176	956075
0.86	7.1	1.5	30	29254	55177	956076
0.87	7.1	1.5	30	42291	55178	956077
0.88	7.1	1.5	30	19601	55179	956080
0.89	7.1	1.5	30	41789	55180	956081
0.90	7.1	1.5	30	32100	55181	956082
0.91	7.1	1.5	30	42292	55182	956083
0.92	7.1	1.5	30	36859	55183	956084
0.93	7.1	1.5	30	42293	55184	956085
0.94	7.1	1.5	30	42167	55185	956086
0.95	7.1	1.5	30	35183	55186	956087
0.96	8.0	1.5	30	37741	55188	956088
0.97	8.0	1.5	30	29255	55189	956089
0.98	8.0	1.5	30	42294	55190	956091
0.99	8.0	1.5	30	41790	55191	956092
1.00	9.0	1.5	30	406	55192	956093
1.01	9.0	1.5	30	34996	55193	956094
1.02	9.0	1.5	30	42876	55195	956095
1.03	9.0	1.5	30	34778	55196	956096
1.04	9.0	1.5	30	43984	55200	956097
1.05	9.0	1.5	30	4774	55201	956098
1.06	9.0	1.5	30	43985	55202	956099
1.07	9.0	1.5	30	42228	55203	956100
1.08	9.0	1.5	30	43198	55204	956101
1.09	9.0	1.5	30	28779	55205	956102
1.10	9.0	1.5	30	407	55206	956103
1.11	9.0	1.5	30	43986	55207	956104
1.12	9.0	1.5	30	43347	55208	956105
1.13	9.0	1.5	30	42853	55209	956106
1.14	9.0	1.5	30	43987	55210	956107
1.15	9.0	1.5	30	3530	55211	956108
1.16	9.0	1.5	30	22712	55212	956109
1.17	9.0	1.5	30	4775	55213	956110
1.18	9.0	1.5	30	42230	55214	956111
1.19	10.0	1.5	30	41791	55215	956112

D _{1 0/-0.004}	L ₁	D _{h5}	L	CARBURE	DICUT	DLC*
1.20	10.0	1.5	30	408	55216	956113
1.21	10.0	1.5	30	42168	55217	956114
1.22	10.0	1.5	30	25751	55218	956115
1.23	10.0	1.5	30	23285	55219	956116
1.24	10.0	1.5	30	45524	55220	956118
1.25	10.0	1.5	30	3531	55221	956119
1.26	10.0	1.5	30	42005	55222	956120
1.27	10.0	1.5	30	3761	55223	956121
1.28	10.0	1.5	30	42169	55224	956122
1.29	10.0	1.5	30	37694	55225	956124
1.30	10.0	1.5	30	409	55226	956125
1.31	10.0	1.5	30	45525	55227	956128
1.32	10.0	1.5	30	29712	55228	956130
1.33	11.2	1.5	30	34695	55229	956131
1.34	11.2	1.5	30	45526	55230	956132
1.35	11.2	1.5	30	3532	55231	956133
1.36	11.2	1.5	30	45527	55232	956134
1.37	11.2	1.5	30	35556	55233	956135
1.38	11.2	1.5	30	45055	55234	956136
1.39	11.2	1.5	30	45297	55235	956137
1.40	11.2	1.5	30	410	55236	956138
1.41	11.2	1.5	30	33499	55237	956139
1.42	11.2	1.5	30	43348	55238	956140
1.43	11.2	1.5	30	45056	55239	956141
1.44	11.2	1.5	30	45528	55240	956142
1.45	11.2	1.5	30	36006	55241	956143
1.46	11.2	1.5	30	45529	55242	956144
1.47	11.2	1.5	30	45530	55243	956145
1.48	11.2	1.5	30	45057	55244	956146
1.49	11.2	1.5	30	35681	55245	956147
1.50	11.2	2.0	38	411	55246	956148
1.51	12.0	2.0	38	27735	55247	956149
1.52	12.0	2.0	38	27736	55248	956150
1.53	12.0	2.0	38	23286	55249	956151
1.54	12.0	2.0	38	45909	55250	956152
1.55	12.0	2.0	38	25686	55251	956153
1.56	12.0	2.0	38	58194	58196	956154
1.57	12.0	2.0	38	55541	58193	956155
1.58	12.0	2.0	38	39953	55252	956156
1.59	12.0	2.0	38	34993	55253	956157

* pour matériaux non-ferreux





P. 63



P. 72

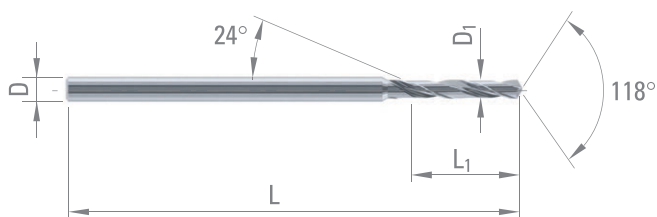

Acier + Pb	Acier faibl. allié	Acier fort. allié	Acier inox aust.	Fontes
Super alliages Ni / Co	Titane, alliage de titane	Alliage Cu Argent Or	Alliage Cu difficile	Alu
Graphite	Plastique			

D _{1 0/-0.004}	L ₁	D _{h5}	L	CARBURE DICUT	DLC*
1.60	12.0	2.0	38	412	55254 956158
1.61	12.0	2.0	38	40288	55255 956159
1.62	12.0	2.0	38	46968	55256 956160
1.63	12.0	2.0	38	45605	55257 956161
1.64	12.0	2.0	38	45910	55258 956162
1.65	12.0	2.0	38	32283	55259 956163
1.66	12.0	2.0	38	47198	55260 956164
1.67	12.0	2.0	38	50763	55261 956165
1.68	12.0	2.0	38	31684	55262 956166
1.69	12.0	2.0	38	45339	55263 956167
1.70	12.0	2.0	38	413	55264 956169
1.71	12.0	2.0	38	45911	55265 956175
1.72	12.0	2.0	38	27925	55266 956177
1.73	12.0	2.0	38	42609	55267 956178
1.74	12.0	2.0	38	45912	55268 956179
1.75	12.0	2.0	38	45734	55269 956180
1.76	12.0	2.0	38	45913	55270 956181
1.77	12.0	2.0	38	38757	61408 956182
1.78	12.0	2.0	38	46957	55271 956183
1.79	12.0	2.0	38	45340	55272 956185
1.80	12.0	2.0	38	31497	55273 956186
1.81	12.0	2.0	38	45914	55274 956187
1.82	12.0	2.0	38	46969	55275 956188
1.83	12.0	2.0	38	58717	61407 956189
1.84	12.0	2.0	38	46970	55276 956190
1.85	12.0	2.0	38	36793	55277 956191
1.86	12.0	2.0	38	50761	55278 956192
1.87	12.0	2.0	38	36487	55279 956195
1.88	12.0	2.0	38	45801	55280 956196
1.89	12.0	2.0	38	45341	55281 956197
1.90	12.0	2.0	38	415	55282 956198
1.91	12.0	2.0	38	45915	55283 956200
1.92	12.0	2.0	38	45916	55284 956201
1.93	12.0	2.0	38	44853	55285 956202
1.94	12.0	2.0	38	45917	55286 956203
1.95	12.0	2.0	38	32284	55287 956204
1.96	12.0	2.0	38	60692	61404 956205
1.97	12.0	2.0	38	50332	61401 956206
1.98	12.0	2.0	38	46959	55288 956207
1.99	12.0	2.0	38	45342	55289 956208

D _{1 0/-0.004}	L ₁	D _{h5}	L	CARBURE DICUT	DLC*
2.00	12.0	2.5	43	416	55290 956209
2.01	12.0	2.5	43	45498	55291 956210
2.02	12.0	2.5	43	48962	61399 956211
2.03	12.0	2.5	43	50685	55292 956212
2.04	12.0	2.5	43	60958	60962 956213
2.05	12.0	2.5	43	40813	55293 956214
2.10	12.0	2.5	43	42295	55294 956215
2.15	12.0	2.5	43	40814	55295 956216
2.20	12.0	2.5	43	418	55296 956217
2.25	12.0	2.5	43	40815	55297 956218
2.30	12.0	2.5	43	419	55298 956219
2.34	12.0	2.5	43	955569	955572 956228
2.35	12.0	2.5	43	6341	55299 956220
2.40	12.0	2.5	43	420	55300 956221
2.45	12.0	2.5	43	40816	55301 956222

* pour matériaux non-ferreux





P. 63



P. 72

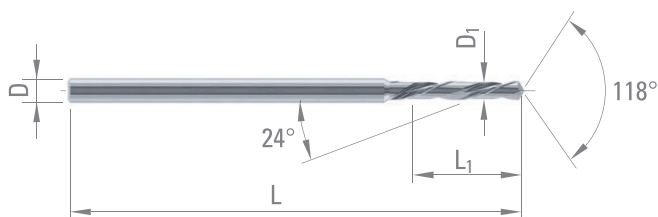

Acier + Pb	Acier faibl. allié	Acier fort. allié	Acier inox aust.	Fontes
Super alliages Ni / Co	Titane, alliage de titane	Alliage Cu Argent Or	Alliage Cu difficile	Alu
Graphite	Plastique			

D _{1 0/-0.004}	L ₁	D _{h5}	L	CARBURE	DICUT
0.10	0.7	1.0	30	36916	
0.11	0.7	1.0	30	36917	
0.12	0.7	1.0	30	36918	
0.13	0.7	1.0	30	36919	
0.14	0.7	1.0	30	36920	
0.15	1.0	1.0	30	36921	
0.16	1.0	1.0	30	36922	
0.17	1.0	1.0	30	38654	
0.18	1.0	1.0	30	36924	
0.19	1.0	1.0	30	36925	
0.20	1.0	1.0	30	36926	952652
0.21	1.0	1.0	30	36927	952653
0.22	1.0	1.0	30	36928	952654
0.23	1.0	1.0	30	36929	952655
0.24	1.0	1.0	30	36930	952656
0.25	1.0	1.0	30	36931	952657
0.26	1.0	1.0	30	36932	952658
0.27	1.0	1.0	30	36933	952659
0.28	1.0	1.0	30	36934	952660
0.29	1.0	1.0	30	36935	952661
0.30	1.5	1.0	30	36936	952662
0.31	1.5	1.0	30	36937	952663
0.32	1.5	1.0	30	36938	952664
0.33	1.5	1.0	30	36939	952665
0.34	1.5	1.0	30	36940	952666
0.35	1.5	1.0	30	36941	952667
0.36	1.5	1.0	30	36942	952669
0.37	1.5	1.0	30	36943	952672
0.38	1.5	1.0	30	36944	952673
0.39	1.5	1.0	30	36945	952674
0.40	2.0	1.0	30	15026	952676
0.41	2.0	1.0	30	35708	952677
0.42	2.0	1.0	30	36946	952678
0.43	2.0	1.0	30	36947	952679
0.44	2.0	1.0	30	36948	952680
0.45	3.6	1.0	30	38054	952681
0.46	3.6	1.0	30	38057	952682
0.47	3.6	1.0	30	38059	952683
0.48	3.6	1.0	30	38062	952684
0.49	4.0	1.0	30	38063	952685

D _{1 0/-0.004}	L ₁	D _{h5}	L	CARBURE	DICUT
0.50	4.0	1.0	30	38065	55302
0.51	4.0	1.0	30	38066	55303
0.52	4.0	1.0	30	38068	55304
0.53	4.0	1.0	30	38069	55305
0.54	4.5	1.0	30	38245	55306
0.55	4.5	1.0	30	38246	55307
0.56	4.5	1.0	30	38190	55308
0.57	4.5	1.0	30	38187	55309
0.58	4.5	1.0	30	38103	55310
0.59	4.5	1.0	30	38070	55311
0.60	4.5	1.0	30	38188	55312
0.61	5.0	1.0	30	38247	55313
0.62	5.0	1.0	30	38364	55314
0.63	5.0	1.0	30	38072	55315
0.64	5.0	1.0	30	38073	55316
0.65	5.0	1.0	30	38075	55317
0.66	5.0	1.0	30	36966	55318
0.67	5.0	1.0	30	36838	55319
0.68	5.6	1.0	30	21766	55320
0.69	5.6	1.0	30	4021	55321
0.70	5.6	1.0	30	450	55322
0.71	5.6	1.0	30	38078	55323
0.72	5.6	1.0	30	38182	55324
0.73	5.6	1.0	30	22294	55325
0.74	5.6	1.0	30	38080	55326
0.75	5.6	1.0	30	36975	55327
0.76	6.3	1.0	30	36976	55328
0.77	6.3	1.0	30	40866	55329
0.78	6.3	1.0	30	36978	55330
0.79	6.3	1.0	30	38082	55331
0.80	6.3	1.5	30	38317	55332
0.81	6.3	1.5	30	36981	55333
0.82	6.3	1.5	30	36982	55334
0.83	6.3	1.5	30	36983	55335
0.84	6.3	1.5	30	38292	55336
0.85	6.3	1.5	30	38293	55337
0.86	7.1	1.5	30	38294	55338
0.87	7.1	1.5	30	38251	55339
0.88	7.1	1.5	30	36988	55340
0.89	7.1	1.5	30	36989	55341





P. 63



P. 72

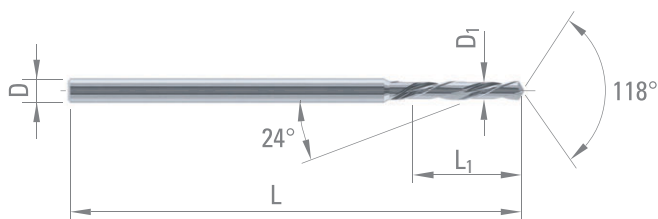

Acier + Pb	Acier faibl. allié	Acier fort. allié	Acier inox aust.	Fontes
Super alliages Ni / Co	Titane, alliage de titane	Alliage Cu Argent Or	Alliage Cu difficile	Alu
Graphite	Plastique			

D _{1 0/-0.004}	L ₁	D _{h5}	L	CARBURE DICUT	
0.90	7.1	1.5	30	24182	55342
0.91	7.1	1.5	30	38295	55343
0.92	7.1	1.5	30	36360	55344
0.93	7.1	1.5	30	35871	55345
0.94	7.1	1.5	30	38086	55346
0.95	7.1	1.5	30	455	55347
0.96	8.0	1.5	30	38296	55348
0.97	8.0	1.5	30	36996	55349
0.98	8.0	1.5	30	36997	55350
0.99	8.0	1.5	30	36998	55351
1.00	9.0	1.5	30	36999	55352
1.01	9.0	1.5	30	37000	55353
1.02	9.0	1.5	30	37001	55354
1.03	9.0	1.5	30	37002	55355
1.04	9.0	1.5	30	37003	55356
1.05	9.0	1.5	30	37004	55357
1.06	9.0	1.5	30	37005	55358
1.07	9.0	1.5	30	37006	55359
1.08	9.0	1.5	30	37007	55360
1.09	9.0	1.5	30	37008	55361
1.10	9.0	1.5	30	457	55362
1.11	9.0	1.5	30	37009	55363
1.12	9.0	1.5	30	37010	55364
1.13	9.0	1.5	30	14573	55365
1.14	9.0	1.5	30	37011	55366
1.15	9.0	1.5	30	19337	55367
1.16	9.0	1.5	30	37012	55368
1.17	9.0	1.5	30	37013	55369
1.18	9.0	1.5	30	37014	55370
1.19	10.0	1.5	30	37015	55371
1.20	10.0	1.5	30	37016	55372
1.21	10.0	1.5	30	26225	55373
1.22	10.0	1.5	30	37017	55374
1.23	10.0	1.5	30	45717	55375
1.24	10.0	1.5	30	37019	55376
1.25	10.0	1.5	30	26763	55377
1.26	10.0	1.5	30	27862	55378
1.27	10.0	1.5	30	6197	55379
1.28	10.0	1.5	30	25663	55380
1.29	10.0	1.5	30	27863	55381

D _{1 0/-0.004}	L ₁	D _{h5}	L	CARBURE DICUT	
1.30	10.0	1.5	30	459	55382
1.31	10.0	1.5	30	37020	55383
1.32	10.0	1.5	30	37021	55384
1.33	11.2	1.5	30	37022	55385
1.34	11.2	1.5	30	45718	55386
1.35	11.2	1.5	30	37024	55387
1.36	11.2	1.5	30	37025	55388
1.37	11.2	1.5	30	37026	55389
1.38	11.2	1.5	30	37027	55390
1.39	11.2	1.5	30	37028	55391
1.40	11.2	1.5	30	460	55392
1.41	11.2	1.5	30	26226	55393
1.42	11.2	1.5	30	37029	55394
1.43	11.2	1.5	30	37030	55395
1.44	11.2	1.5	30	37031	55396
1.45	11.2	1.5	30	26459	55397
1.46	11.2	1.5	30	37032	55398
1.47	11.2	1.5	30	37033	55399
1.48	11.2	1.5	30	37034	55400
1.49	11.2	1.5	30	37035	55401
1.50	11.2	2.0	38	461	55402
1.51	12.0	2.0	38	38089	55403
1.52	12.0	2.0	38	38962	55404
1.53	12.0	2.0	38	38938	55405
1.54	12.0	2.0	38	45531	55406
1.55	12.0	2.0	38	38090	55407
1.56	12.0	2.0	38	45532	55408
1.57	12.0	2.0	38	45351	55409
1.58	12.0	2.0	38	38252	55410
1.59	12.0	2.0	38	45533	55411
1.60	12.0	2.0	38	37234	55412
1.61	12.0	2.0	38	40655	55413
1.62	12.0	2.0	38	29286	55414
1.63	12.0	2.0	38	40910	55415
1.64	12.0	2.0	38	41297	55416
1.65	12.0	2.0	38	37235	55417
1.66	12.0	2.0	38	45534	55418
1.67	12.0	2.0	38	44015	55419
1.68	12.0	2.0	38	38092	55420
1.69	12.0	2.0	38	45535	55421





P. 63



P. 72



DIN
1899

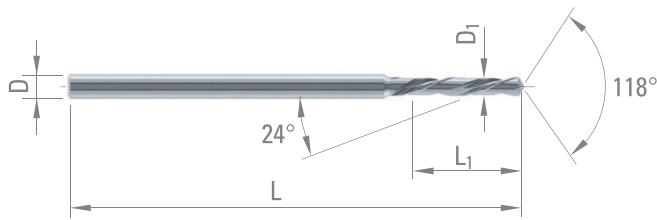

Acier + Pb	Acier faibl. allié	Acier fort. allié	Acier inox aust.	Fontes
Super alliages Ni / Co	Titane, alliage de titane	Alliage Cu Argent Or	Alliage Cu difficile	Alu
Graphite	Plastique			

$D_{10/-0.004}$	L_1	D_{h5}	L	CARBURE DICUT	
1.70	12.0	2.0	38	463	55422
1.71	12.0	2.0	38	45536	55423
1.72	12.0	2.0	38	45075	55424
1.73	12.0	2.0	38	43415	55425
1.74	12.0	2.0	38	45537	55426
1.75	12.0	2.0	38	38093	55427
1.76	12.0	2.0	38	58052	58054
1.77	12.0	2.0	38	42174	55428
1.78	12.0	2.0	38	57881	57888
1.79	12.0	2.0	38	58197	58199
1.80	12.0	2.0	38	464	55429
1.81	12.0	2.0	38	58636	61392
1.82	12.0	2.0	38	26183	55430
1.83	12.0	2.0	38	61388	61390
1.84	12.0	2.0	38	50611	55431
1.85	12.0	2.0	38	38094	55432
1.86	12.0	2.0	38	61385	61387
1.87	12.0	2.0	38	42119	55433
1.88	12.0	2.0	38	61382	61384
1.89	12.0	2.0	38	50657	55434
1.90	12.0	2.0	38	41217	55435
1.91	12.0	2.0	38	61150	61367
1.92	12.0	2.0	38	48963	57890
1.93	12.0	2.0	38	50158	58056
1.94	12.0	2.0	38	60780	60782
1.95	12.0	2.0	38	45719	55436
1.96	12.0	2.0	38	61368	61370
1.97	12.0	2.0	38	61372	61371
1.98	12.0	2.0	38	44254	57892
1.99	12.0	2.0	38	58741	60784
2.00	12.0	2.5	43	466	55437
2.01	12.0	2.5	43	38096	55438
2.02	12.0	2.5	43	47857	55439
2.03	12.0	2.5	43	61256	61375
2.04	12.0	2.5	43	61376	61378
2.05	12.0	2.5	43	61379	61381
2.10	12.0	2.5	43	467	55440
2.12	12.0	2.5	43	47858	55441
2.15	12.0	2.5	43	38097	55442
2.45	12.0	2.5	43	38098	55443





P. 63



P. 74

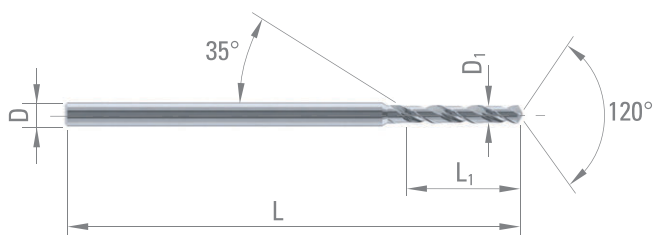

Acier + Pb	Acier faibl. allié	Acier fort. allié	Acier inox aust.	Fontes
Super alliages Ni / Co	Titane, alliage de titane	Alliage Cu Argent Or	Alliage Cu difficile	Alu

D _{1 0/-0.004}	L ₁	D _{h5}	L	CARBURE DICUT	
0.50	4.0	1.0	30	21228	57565
0.55	4.5	1.0	30	39029	57566
0.60	4.5	1.0	30	176	57567
0.65	5.0	1.0	30	39030	57568
0.70	5.6	1.0	30	178	55679
0.75	5.6	1.0	30	39031	55681
0.80	6.3	1.5	30	180	55683
0.81	6.3	1.5	30	957990	957991
0.82	6.3	1.5	30	957040	957994
0.83	6.3	1.5	30	45775	957802
0.84	6.3	1.5	30	45776	957804
0.85	6.3	1.5	30	181	55685
0.86	7.1	1.5	30	957995	957996
0.87	7.1	1.5	30	957998	957999
0.88	7.1	1.5	30	958001	958002
0.89	7.1	1.5	30	56626	957806
0.90	7.1	1.5	30	182	55687
0.91	7.1	1.5	30	958006	958007
0.92	7.1	1.5	30	957949	958004
0.93	7.1	1.5	30	957042	957808
0.94	7.1	1.5	30	957043	957810
0.95	7.1	1.5	30	39032	55689
0.96	9.0	1.5	30	49329	957812
0.97	9.0	1.5	30	957045	957829
0.98	9.0	1.5	30	43498	957831
0.99	9.0	1.5	30	61003	957834
1.00	9.0	1.5	30	184	55691
1.01	9.0	1.5	30	48709	957865
1.02	9.0	1.5	30	58334	957867
1.03	9.0	1.5	30	958010	958011
1.04	9.0	1.5	30	958013	958015
1.05	9.0	1.5	30	39033	55757
1.06	9.0	1.5	30	958017	958018
1.07	9.0	1.5	30	58335	957879
1.08	9.0	1.5	30	57722	957884
1.09	9.0	1.5	30	958020	958021
1.10	9.0	1.5	30	39034	55759
1.11	9.0	1.5	30	45752	957887
1.12	9.0	1.5	30	62921	954726

D _{1 0/-0.004}	L ₁	D _{h5}	L	CARBURE DICUT	
1.13	9.0	1.5	30	957889	954727
1.14	9.0	1.5	30	958023	958024
1.15	9.0	1.5	30	39035	55761
1.16	10.0	1.5	30	50299	957893
1.17	10.0	1.5	30	52449	957895
1.18	10.0	1.5	30	58333	957897
1.19	10.0	1.5	30	958026	958027
1.20	10.0	1.5	30	39036	55762
1.21	10.0	1.5	30	50233	957899
1.22	10.0	1.5	30	59610	957901
1.23	10.0	1.5	30	46797	957902
1.24	10.0	1.5	30	958029	958030
1.25	10.0	1.5	30	39037	55764
1.26	10.0	1.5	30	65858	50057
1.27	10.0	1.5	30	50558	957912
1.28	10.0	1.5	30	958032	958033
1.29	10.0	1.5	30	958035	958037
1.30	10.0	1.5	30	187	55766
1.31	11.2	1.5	30	958199	958200
1.32	11.2	1.5	30	50068	957914
1.33	11.2	1.5	30	44387	957916
1.34	11.2	1.5	30	53518	958203
1.35	11.2	1.5	30	39038	55768
1.36	11.2	1.5	30	58147	957921
1.37	11.2	1.5	30	958205	958206
1.38	11.2	1.5	30	958208	958209
1.39	11.2	1.5	30	958211	958212
1.40	11.2	1.5	30	188	55777
1.45	11.2	1.5	30	39039	55779
1.50	11.2	2.0	38	39040	55780
1.55	12.0	2.0	38	52209	55782
1.60	12.0	2.0	38	52210	55786
1.65	12.0	2.0	38	52211	54986
1.70	12.0	2.0	38	191	55789
1.75	12.0	2.0	38	52212	55791
1.80	12.0	2.0	38	49082	55793
1.85	12.0	2.0	38	52213	55795
1.90	12.0	2.0	38	193	55797
1.95	12.0	2.0	38	52214	55799



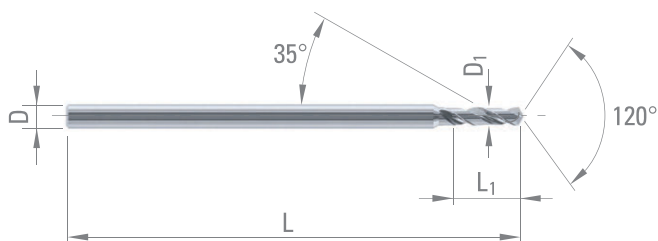

Acier + Pb	Acier faibl. allié	Acier fort. allié	Acier inox aust.	Fontes
Super alliages Ni / Co	Titane, alliage de titane	Alliage Cu Argent Or	Alliage Cu difficile	Alu

D _{1 0/-0.004}	L ₁	D _{h5}	L	CARBURE DICUT	
0.20	1.5	1.5	30	950342	950234
0.21	1.5	1.5	30	950235	950248
0.22	1.5	1.5	30	950236	950249
0.23	1.5	1.5	30	950240	950250
0.24	1.5	1.5	30	950241	950251
0.25	2.0	1.5	30	950253	950278
0.26	2.0	1.5	30	950254	950279
0.27	2.0	1.5	30	950255	950280
0.28	2.0	1.5	30	950256	950281
0.29	2.0	1.5	30	950084	950282
0.30	2.0	1.5	30	950276	950283
0.31	2.5	1.5	30	950284	950299
0.32	2.5	1.5	30	950285	950301
0.33	2.5	1.5	30	950286	950302
0.34	2.5	1.5	30	950287	950303
0.35	2.5	1.5	30	950288	950304
0.36	2.5	1.5	30	950085	950305
0.37	2.5	1.5	30	950289	950306
0.38	2.5	1.5	30	950290	950307
0.39	3.0	1.5	30	950308	950330
0.40	3.0	1.5	30	950309	950331
0.41	3.0	1.5	30	950310	950332
0.42	3.0	1.5	30	950311	950333
0.43	3.0	1.5	30	950312	950334
0.44	3.0	1.5	30	950313	950335
0.45	3.0	1.5	30	950314	950336
0.46	3.0	1.5	30	950315	950337
0.47	3.0	1.5	30	950316	950338
0.48	3.0	1.5	30	950317	950339
0.49	3.0	1.5	30	950318	950340
0.50	4.0	1.5	30	60922	61017
0.51	4.0	1.5	30	60923	61018
0.52	4.0	1.5	30	60924	61020
0.53	4.0	1.5	30	60925	61021
0.54	4.0	1.5	30	60926	61022
0.55	4.0	1.5	30	60927	61023
0.56	4.0	1.5	30	60928	61024
0.57	4.0	1.5	30	60929	61025
0.58	4.0	1.5	30	60930	61026
0.59	4.0	1.5	30	60931	61027

D _{1 0/-0.004}	L ₁	D _{h5}	L	CARBURE DICUT	
0.60	4.5	1.5	30	60932	61028
0.61	4.5	1.5	30	60933	61029
0.62	4.5	1.5	30	60934	61030
0.63	4.5	1.5	30	60935	61031
0.64	4.5	1.5	30	60936	61032
0.65	4.5	1.5	30	60937	61033
0.66	4.5	1.5	30	60938	61034
0.67	4.5	1.5	30	60939	61035
0.68	4.5	1.5	30	56623	61036
0.69	4.5	1.5	30	60940	61037
0.70	4.5	1.5	30	56364	57571
0.71	4.5	1.5	30	56365	57573
0.72	4.5	1.5	30	56366	57575
0.73	4.5	1.5	30	56367	57577
0.74	4.5	1.5	30	56368	57587
0.75	4.5	1.5	30	56369	57589
0.76	4.5	1.5	30	56370	57579
0.77	4.5	1.5	30	56371	57581
0.78	4.5	1.5	30	56372	57583
0.79	4.5	1.5	30	56373	57585
0.80	5.0	1.5	30	52140	55801
0.81	5.0	1.5	30	52141	55803
0.82	5.0	1.5	30	52142	55805
0.83	5.0	1.5	30	52143	55807
0.84	5.0	1.5	30	52144	55809
0.85	5.0	1.5	30	52145	55811
0.86	5.0	1.5	30	52146	55813
0.87	5.0	1.5	30	52147	55815
0.88	5.0	1.5	30	52148	55817
0.89	5.0	1.5	30	52149	55819
0.90	5.0	1.5	30	52150	55821
0.91	5.0	1.5	30	52151	55823
0.92	5.0	1.5	30	52152	55825
0.93	5.0	1.5	30	52153	55827
0.94	5.0	1.5	30	52154	55829
0.95	5.0	1.5	30	52155	55831
0.96	5.0	1.5	30	52156	55833
0.97	5.0	1.5	30	52157	55835
0.98	5.0	1.5	30	52158	55837
0.99	5.0	1.5	30	52159	55839





P. 63



P. 74

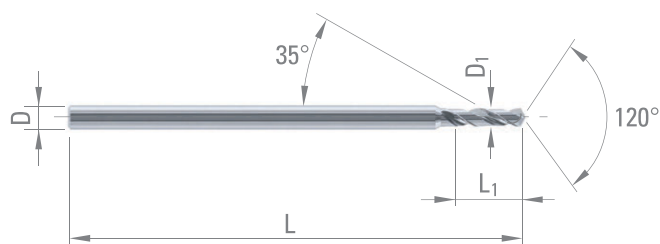

Acier + Pb	Acier faibl. allié	Acier fort. allié	Acier inox aust.	Fontes
Super alliages Ni / Co	Titane, alliage de titane	Alliage Cu Argent Or	Alliage Cu difficile	Alu

D _{1 0/-0.004}	L ₁	D _{h5}	L	CARBURE DICUT	
1.00	5.0	1.5	30	52160	55841
1.01	5.0	1.5	30	52161	55842
1.02	5.0	1.5	30	52162	55844
1.03	5.0	1.5	30	52163	55848
1.04	5.0	1.5	30	52164	55850
1.05	5.0	1.5	30	52165	55852
1.06	5.0	1.5	30	52166	55854
1.07	5.0	1.5	30	52167	55856
1.08	5.0	1.5	30	52168	55858
1.09	5.0	1.5	30	52169	55860
1.10	5.0	1.5	30	52170	55861
1.11	5.0	1.5	30	52171	55863
1.12	5.0	1.5	30	52172	55865
1.13	5.0	1.5	30	52173	55871
1.14	5.0	1.5	30	52174	55872
1.15	5.0	1.5	30	52175	55873
1.16	5.0	1.5	30	52176	55875
1.17	5.0	1.5	30	52177	55877
1.18	5.0	1.5	30	52178	55878
1.19	5.0	1.5	30	52179	55893
1.20	6.0	1.5	30	52180	55880
1.21	6.0	1.5	30	52181	55882
1.22	6.0	1.5	30	52182	55884
1.23	6.0	1.5	30	52183	55886
1.24	6.0	1.5	30	52184	55896
1.25	6.0	1.5	30	52185	55898
1.26	6.0	1.5	30	52186	55900
1.27	6.0	1.5	30	52187	55902
1.28	6.0	1.5	30	52188	55904
1.29	6.0	1.5	30	52189	55906
1.30	6.0	1.5	30	52190	55908
1.31	6.0	1.5	30	52191	55910
1.32	6.0	1.5	30	52192	55912
1.33	6.0	1.5	30	52193	55914
1.34	6.0	1.5	30	52194	55916
1.35	6.0	1.5	30	52195	55918
1.36	6.0	1.5	30	52196	55920
1.37	6.0	1.5	30	52197	55922
1.38	6.0	1.5	30	52198	55924
1.39	6.0	1.5	30	52199	55926

D _{1 0/-0.004}	L ₁	D _{h5}	L	CARBURE DICUT	
1.40	6.0	1.5	30	52200	55929
1.41	6.0	1.5	30	52201	55932
1.42	6.0	1.5	30	52202	55934
1.43	6.0	1.5	30	52203	55936
1.44	6.0	1.5	30	52204	55938
1.45	6.0	1.5	30	52205	55940
1.46	6.0	1.5	30	52206	55942
1.47	6.0	1.5	30	52207	55944
1.48	6.0	1.5	30	52208	55946
1.49	6.0	1.5	30	52216	55948
1.50	7.0	2.0	38	56431	57591
1.51	7.0	2.0	38	56374	57593
1.52	7.0	2.0	38	56375	57595
1.53	7.0	2.0	38	56376	57597
1.54	7.0	2.0	38	56377	57599
1.55	7.0	2.0	38	56378	57601
1.56	7.0	2.0	38	56379	57603
1.57	7.0	2.0	38	56380	57605
1.58	7.0	2.0	38	56381	57607
1.59	7.0	2.0	38	56382	57609
1.60	7.0	2.0	38	56383	57611
1.61	7.0	2.0	38	56384	57613
1.62	7.0	2.0	38	56385	57615
1.63	7.0	2.0	38	56386	57617
1.64	7.0	2.0	38	56387	57619
1.65	7.0	2.0	38	56388	57621
1.66	7.0	2.0	38	56389	57623
1.67	7.0	2.0	38	56390	57625
1.68	7.0	2.0	38	56391	57627
1.69	7.0	2.0	38	56392	57629
1.70	7.0	2.0	38	56393	57631
1.71	7.0	2.0	38	56394	57633
1.72	7.0	2.0	38	56395	57635
1.73	7.0	2.0	38	56396	57637
1.74	7.0	2.0	38	56397	57639
1.75	7.0	2.0	38	56398	57641
1.76	8.0	2.0	38	56399	57643
1.77	8.0	2.0	38	56400	57645
1.78	8.0	2.0	38	56401	57647
1.79	8.0	2.0	38	56402	57649





P. 63



P. 74

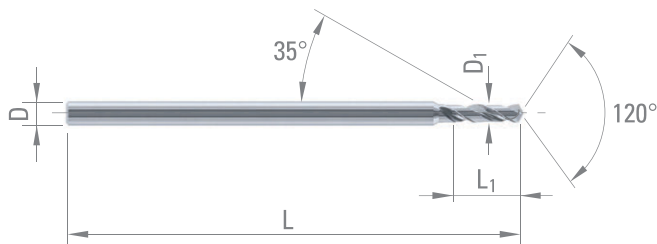

Acier + Pb	Acier faibl. allié	Acier fort. allié	Acier inox aust.	Fontes
Super alliages Ni / Co	Titane, alliage de titane	Alliage Cu Argent Or	Alliage Cu difficile	Alu

D _{1 0/-0.004}	L ₁	D _{h5}	L	CARBURE DICUT	
1.80	8.0	2.0	38	56403	57651
1.81	8.0	2.0	38	56404	57653
1.82	8.0	2.0	38	56405	57655
1.83	8.0	2.0	38	56406	57657
1.84	8.0	2.0	38	56407	57659
1.85	8.0	2.0	38	56408	57661
1.86	8.0	2.0	38	56409	57663
1.87	8.0	2.0	38	56410	57665
1.88	8.0	2.0	38	56411	57667
1.89	8.0	2.0	38	56412	57669
1.90	8.0	2.0	38	56413	57671
1.91	8.0	2.0	38	56414	57673
1.92	8.0	2.0	38	56415	57675
1.93	8.0	2.0	38	56416	57677
1.94	8.0	2.0	38	56417	57679
1.95	8.0	2.0	38	56418	57681
1.96	8.0	2.0	38	56419	57683
1.97	8.0	2.0	38	56420	57685
1.98	8.0	2.0	38	56421	57687
1.99	8.0	2.0	38	56422	57689
2.00	9.0	2.5	43	951030	951165
2.01	9.0	2.5	43	951034	951166
2.02	9.0	2.5	43	951035	951167
2.03	9.0	2.5	43	951036	951168
2.04	9.0	2.5	43	951039	951169
2.05	9.0	2.5	43	59122	951170
2.06	9.0	2.5	43	951040	951171
2.07	9.0	2.5	43	951041	951172
2.08	9.0	2.5	43	951042	951173
2.09	9.0	2.5	43	951043	951214
2.10	9.0	2.5	43	951058	951215
2.11	9.0	2.5	43	951059	951216
2.12	9.0	2.5	43	951060	951217
2.13	9.0	2.5	43	951061	951218
2.14	9.0	2.5	43	951062	951219
2.15	9.0	2.5	43	951063	951220
2.16	9.0	2.5	43	951064	951621
2.17	9.0	2.5	43	951065	951622
2.18	9.0	2.5	43	951066	951624
2.19	9.0	2.5	43	951067	951625

D _{1 0/-0.004}	L ₁	D _{h5}	L	CARBURE DICUT	
2.20	9.0	2.5	43	951068	951626
2.21	9.0	2.5	43	951069	951627
2.22	9.0	2.5	43	951070	951628
2.23	9.0	2.5	43	951071	951629
2.24	9.0	2.5	43	951072	951630
2.25	9.0	2.5	43	951073	951631
2.26	9.0	2.5	43	951074	951632
2.27	9.0	2.5	43	951075	951633
2.28	9.0	2.5	43	951076	951634
2.29	9.0	2.5	43	951077	951636
2.30	9.0	2.5	43	951078	951637
2.31	9.0	2.5	43	951079	951638
2.32	9.0	2.5	43	951080	951639
2.33	9.0	2.5	43	951081	951640
2.34	9.0	2.5	43	951082	951641
2.35	9.0	2.5	43	951083	951642
2.36	9.0	2.5	43	951084	951643
2.37	9.0	2.5	43	951085	951644
2.38	9.0	2.5	43	951086	951645
2.39	9.0	2.5	43	951087	951646
2.40	9.0	2.5	43	951089	951647
2.41	9.0	2.5	43	951090	951648
2.42	9.0	2.5	43	951091	951649
2.43	9.0	2.5	43	951092	951650
2.44	9.0	2.5	43	951093	951651
2.45	9.0	2.5	43	951094	951652
2.46	9.0	2.5	43	951095	951653
2.47	9.0	2.5	43	951096	951654
2.48	9.0	2.5	43	951097	951655
2.49	9.0	2.5	43	951098	951656



FORETS HÉLICOÏDAUX
CORPS RENFORCÉ
TOLÉRANCE 0/+4 μ m

Z = 2



P. 63



P. 74

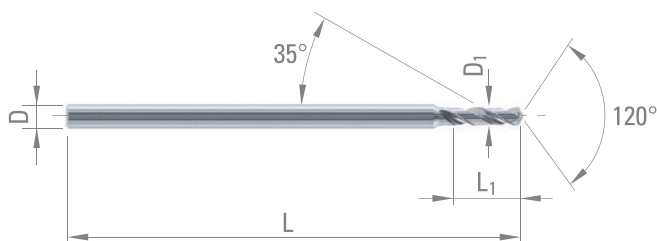

Acier + Pb	Acier faibl. allié	Acier fort. allié	Acier inox aust.	Fontes
Super alliages Ni / Co	Titane, alliage de titane	Alliage Cu Argent Or	Alliage Cu difficile	Alu

D ₁ 0/+0.004	L ₁	D _{h5}	L	CARBURE DICUT	
0.20	1.5	1.5	30	990662	990642
0.21	1.5	1.5	30	990643	990676
0.22	1.5	1.5	30	990644	990677
0.23	1.5	1.5	30	990674	990678
0.24	1.5	1.5	30	990675	990679
0.25	2.0	1.5	30	990680	990659
0.26	2.0	1.5	30	990681	990660
0.27	2.0	1.5	30	990682	990663
0.28	2.0	1.5	30	990683	990664
0.29	2.0	1.5	30	990631	990665
0.30	2.0	1.5	30	990658	990666
0.31	2.5	1.5	30	990667	990645
0.32	2.5	1.5	30	990668	990646
0.33	2.5	1.5	30	990669	990647
0.34	2.5	1.5	30	990670	990648
0.35	2.5	1.5	30	990671	990649
0.36	2.5	1.5	30	990632	990650
0.37	2.5	1.5	30	990672	990651
0.38	2.5	1.5	30	990673	990652
0.39	3.0	1.5	30	990653	990633
0.40	3.0	1.5	30	990654	990634
0.41	3.0	1.5	30	990655	990635
0.42	3.0	1.5	30	990656	990636
0.43	3.0	1.5	30	990684	990637
0.44	3.0	1.5	30	990685	990638
0.45	3.0	1.5	30	990686	990639
0.46	3.0	1.5	30	990687	990640
0.47	3.0	1.5	30	990688	990641
0.48	3.0	1.5	30	990689	990657
0.49	3.0	1.5	30	990690	990661
0.50	4.0	1.5	30	990616	990605
0.51	4.0	1.5	30	990617	990606
0.52	4.0	1.5	30	990618	990607
0.53	4.0	1.5	30	990619	990608
0.54	4.0	1.5	30	990620	990609
0.55	4.0	1.5	30	990621	990610
0.56	4.0	1.5	30	990622	990630
0.57	4.0	1.5	30	990623	990592
0.58	4.0	1.5	30	990624	990593
0.59	4.0	1.5	30	990625	990594
0.60	4.5	1.5	30	990626	990595
0.61	4.5	1.5	30	990627	990596
0.62	4.5	1.5	30	990628	990597
0.63	4.5	1.5	30	990629	990598
0.64	4.5	1.5	30	990599	990604

D ₁ 0/+0.004	L ₁	D _{h5}	L	CARBURE DICUT	
0.65	4.5	1.5	30	990600	990612
0.66	4.5	1.5	30	990601	990613
0.67	4.5	1.5	30	990602	990614
0.68	4.5	1.5	30	990440	990615
0.69	4.5	1.5	30	990603	990611
0.70	4.5	1.5	30	990523	990576
0.71	4.5	1.5	30	990524	990577
0.72	4.5	1.5	30	990525	990578
0.73	4.5	1.5	30	990526	990579
0.74	4.5	1.5	30	990527	990581
0.75	4.5	1.5	30	990528	990582
0.76	4.5	1.5	30	990529	990588
0.77	4.5	1.5	30	990530	990589
0.78	4.5	1.5	30	990531	990590
0.79	4.5	1.5	30	990532	990591
0.80	5.0	1.5	30	990426	990485
0.81	5.0	1.5	30	990410	990550
0.82	5.0	1.5	30	990411	990551
0.83	5.0	1.5	30	990412	990552
0.84	5.0	1.5	30	990413	990470
0.85	5.0	1.5	30	990414	990471
0.86	5.0	1.5	30	990415	990472
0.87	5.0	1.5	30	990416	990473
0.88	5.0	1.5	30	990417	990504
0.89	5.0	1.5	30	990418	990505
0.90	5.0	1.5	30	990419	990506
0.91	5.0	1.5	30	990420	990507
0.92	5.0	1.5	30	990421	990508
0.93	5.0	1.5	30	990422	990509
0.94	5.0	1.5	30	990423	990510
0.95	5.0	1.5	30	990424	990511
0.96	5.0	1.5	30	990425	990512
0.97	5.0	1.5	30	990444	990474
0.98	5.0	1.5	30	990445	990475
0.99	5.0	1.5	30	990446	990476
1.00	5.0	1.5	30	990447	990477
1.01	5.0	1.5	30	990448	990478
1.02	5.0	1.5	30	990339	990479
1.03	5.0	1.5	30	990340	990480
1.04	5.0	1.5	30	990341	990543
1.05	5.0	1.5	30	990441	990544
1.06	5.0	1.5	30	990442	990449
1.07	5.0	1.5	30	990443	990488
1.08	5.0	1.5	30	990427	990489
1.09	5.0	1.5	30	990428	990490





P. 63



P. 74

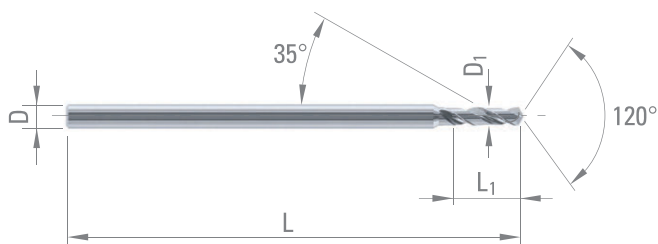

Acier + Pb	Acier faibl. allié	Acier fort. allié	Acier inox aust.	Fontes
Super alliages Ni / Co	Titane, alliage de titane	Alliage Cu Argent Or	Alliage Cu difficile	Alu

D ₁ 0/+0.004	L ₁	D _{h5}	L	CARBURE DICUT	
1.10	5.0	1.5	30	990429	990491
1.11	5.0	1.5	30	990430	990492
1.12	5.0	1.5	30	990431	990493
1.13	5.0	1.5	30	990432	990494
1.14	5.0	1.5	30	990433	990495
1.15	5.0	1.5	30	990434	990496
1.16	5.0	1.5	30	990435	990497
1.17	5.0	1.5	30	990436	990498
1.18	5.0	1.5	30	990437	990499
1.19	5.0	1.5	30	990438	990466
1.20	6.0	1.5	30	990439	990500
1.21	6.0	1.5	30	990342	990371
1.22	6.0	1.5	30	990343	990372
1.23	6.0	1.5	30	990344	990373
1.24	6.0	1.5	30	990345	990517
1.25	6.0	1.5	30	990346	990518
1.26	6.0	1.5	30	990347	990368
1.27	6.0	1.5	30	990348	990369
1.28	6.0	1.5	30	990349	990370
1.29	6.0	1.5	30	990350	990458
1.30	6.0	1.5	30	990351	990459
1.31	6.0	1.5	30	990352	990460
1.32	6.0	1.5	30	990353	990461
1.33	6.0	1.5	30	990354	990462
1.34	6.0	1.5	30	990355	990463
1.35	6.0	1.5	30	990356	990464
1.36	6.0	1.5	30	990357	990465
1.37	6.0	1.5	30	990358	990467
1.38	6.0	1.5	30	990359	990468
1.39	6.0	1.5	30	990360	990469
1.40	6.0	1.5	30	990361	990393
1.41	6.0	1.5	30	990362	990401
1.42	6.0	1.5	30	990363	990402
1.43	6.0	1.5	30	990364	990403
1.44	6.0	1.5	30	990365	990404
1.45	6.0	1.5	30	990366	990405
1.46	6.0	1.5	30	990367	990406
1.47	6.0	1.5	30	990331	990407
1.48	6.0	1.5	30	990332	990408
1.49	6.0	1.5	30	990333	990409
1.50	7.0	2.0	38	990400	990583
1.51	7.0	2.0	38	990533	990584
1.52	7.0	2.0	38	990534	990560
1.53	7.0	2.0	38	990535	990561
1.54	7.0	2.0	38	990536	990481

D ₁ 0/+0.004	L ₁	D _{h5}	L	CARBURE DICUT	
1.55	7.0	2.0	38	990537	990482
1.56	7.0	2.0	38	990538	990483
1.57	7.0	2.0	38	990539	990484
1.58	7.0	2.0	38	990540	990501
1.59	7.0	2.0	38	990541	990502
1.60	7.0	2.0	38	990542	990503
1.61	7.0	2.0	38	990545	990486
1.62	7.0	2.0	38	990546	990487
1.63	7.0	2.0	38	990547	990513
1.64	7.0	2.0	38	990548	990514
1.65	7.0	2.0	38	990549	990515
1.66	7.0	2.0	38	990519	990516
1.67	7.0	2.0	38	990520	990562
1.68	7.0	2.0	38	990521	990563
1.69	7.0	2.0	38	990522	990564
1.70	7.0	2.0	38	990374	990565
1.71	7.0	2.0	38	990375	990585
1.72	7.0	2.0	38	990376	990586
1.73	7.0	2.0	38	990377	990587
1.74	7.0	2.0	38	990378	990553
1.75	7.0	2.0	38	990394	990554
1.76	8.0	2.0	38	990395	990555
1.77	8.0	2.0	38	990396	990556
1.78	8.0	2.0	38	990397	990557
1.79	8.0	2.0	38	990398	990558
1.80	8.0	2.0	38	990399	990559
1.81	8.0	2.0	38	990379	990566
1.82	8.0	2.0	38	990380	990567
1.83	8.0	2.0	38	990381	990568
1.84	8.0	2.0	38	990334	990569
1.85	8.0	2.0	38	990335	990570
1.86	8.0	2.0	38	990336	990571
1.87	8.0	2.0	38	990337	990572
1.88	8.0	2.0	38	990338	990573
1.89	8.0	2.0	38	990382	990574
1.90	8.0	2.0	38	990383	990575
1.91	8.0	2.0	38	990384	990450
1.92	8.0	2.0	38	990385	990451
1.93	8.0	2.0	38	990386	990452
1.94	8.0	2.0	38	990387	990453
1.95	8.0	2.0	38	990388	990454
1.96	8.0	2.0	38	990389	990455
1.97	8.0	2.0	38	990390	990456
1.98	8.0	2.0	38	990391	990457
1.99	8.0	2.0	38	990392	990580



FORETS HÉLICOÏDAUX
POUR LA FABRICATION DES CADRANS

Z = 2



P. 63



P. 74

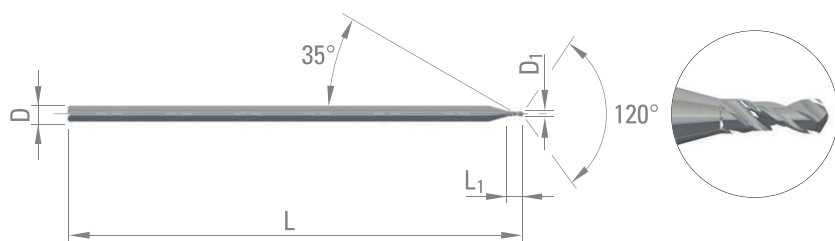

Acier + Pb	Acier faibl. allié	Acier fort. allié	Acier inox aust.	Fontes
Super alliages Ni / Co	Titane, alliage de titane	Alliage Cu Argent Or	Alliage Cu difficile	Alu
Nacre				

$D_{10/-0.004}$	L_1	D_{h5}	L	CARBURE
0.15	1.0	1.0	30	332714
0.16	1.0	1.0	30	332715
0.17	1.0	1.0	30	332716
0.18	1.0	1.0	30	332717
0.19	1.0	1.0	30	332718
0.20	1.0	1.0	30	328127
0.21	1.0	1.0	30	332719
0.22	1.0	1.0	30	332720
0.23	1.0	1.0	30	332721
0.24	1.0	1.0	30	332722
0.25	1.0	1.0	30	332723
0.26	1.0	1.0	30	332724
0.27	1.0	1.0	30	332001
0.28	1.0	1.0	30	332726
0.29	1.0	1.0	30	332727
0.30	1.0	1.0	30	332728
0.31	1.0	1.0	30	333573
0.32	1.0	1.0	30	333574



DIXI 1138

FORETS HÉLICOÏDAUX CORPS RENFORCÉ

Z = 2



P. 63



P. 74



$D_1 \geq 0.5$

$\emptyset 0.05 < \emptyset 0.50$

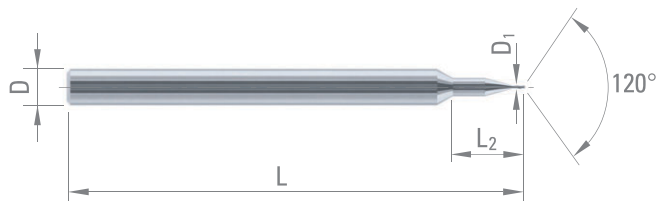

$\emptyset 0.50 \leq \emptyset 2.80$

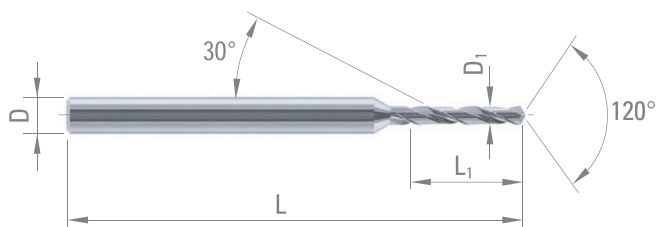

$D_{1\ 0/-0.004}$	L_1	D_2	L_2	D_{h5}	L	CARBURE	TiAIN
0.05	0.35	1.5	5.35	3	38	962810	
0.06	0.40	1.5	5.40	3	38	962809	
0.07	0.50	1.5	5.50	3	38	962808	
0.08	0.60	1.5	5.65	3	38	962807	
0.09	0.65	1.5	5.70	3	38	962806	
0.10	0.70	1.5	5.70	3	38	960016	960258
0.15	1.00	1.5	6.00	3	38	960014	200513
0.20	1.00	1.5	6.00	3	38	960013	200512
0.25	1.00	1.5	6.00	3	38	960012	200511
0.30	1.50	1.5	6.50	3	38	960011	200510
0.35	1.50	1.5	6.50	3	38	960010	200509
0.40	2.00	1.5	7.00	3	38	960009	200508
0.45	3.60	1.5	8.60	3	38	960007	200507

$D_{1\ 0/-0.004}$	L_1	D_{h5}	L	CARBURE	TiAIN
0.50	4.0	3	38	200157	200439
0.53	4.5	3	38	960034	200514
0.55	4.5	3	38	200189	200471
0.60	4.5	3	38	200148	200429
0.62	5.0	3	38	960035	200515
0.65	5.0	3	38	200190	200472
0.70	5.6	3	38	200149	200431
0.71	5.6	3	38	960036	200516
0.75	5.6	3	38	200191	200473
0.80	6.3	3	38	200150	200432
0.81	6.3	3	38	200210	200492
0.82	6.3	3	38	200185	200467
0.83	6.3	3	38	200167	200449
0.84	6.3	3	38	200168	200450
0.85	6.3	3	38	200151	200433
0.86	7.1	3	38	200211	200493
0.87	7.1	3	38	200207	200489
0.88	7.1	3	38	200208	200490
0.89	7.1	3	38	200204	200486
0.90	7.1	3	38	200152	200434
0.91	7.1	3	38	200209	200491
0.92	7.1	3	38	200213	200495
0.93	7.1	3	38	200184	200466
0.94	7.1	3	38	200186	200468
0.95	7.1	3	38	200192	200474
0.96	9.0	3	38	200160	200442
0.97	9.0	3	38	200187	200469
0.98	9.0	3	38	200201	200483
0.99	9.0	3	38	200182	200464
1.00	9.0	3	38	959533	200430
1.01	9.0	3	38	200169	200451

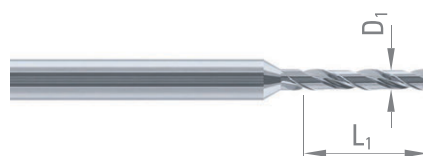
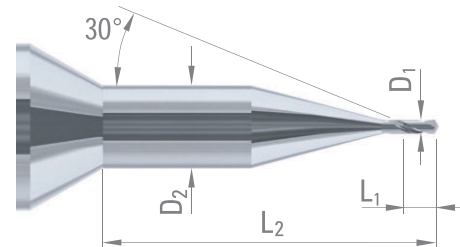

Acier + Pb	Acier faibl. allié	Acier fort. allié	Acier inox aust.	Fontes
Super alliages Ni / Co	Titane, alliage de titane	Alliage Cu Argent Or	Alliage Cu difficile	Alu



DIXI 1138

$D_{10/-0.004}$	L_1	D_{h5}	L	CARBURE	TiAlN
1.02	9.0	3	38	200178	200460
1.03	9.0	3	38	200214	200496
1.04	9.0	3	38	200215	200497
1.05	9.0	3	38	200193	200475
1.06	9.0	3	38	200219	200501
1.07	9.0	3	38	200179	200461
1.08	9.0	3	38	200180	200462
1.09	9.0	3	38	200216	200498
1.10	9.0	3	38	200194	200476
1.11	9.0	3	38	200164	200446
1.12	9.0	3	38	200183	200465
1.13	9.0	3	38	200212	200494
1.14	9.0	3	38	200220	200502
1.15	9.0	3	38	200195	200477
1.16	10.0	3	38	200166	200448
1.17	10.0	3	38	200163	200445
1.18	10.0	3	38	200177	200459
1.19	10.0	3	38	200217	200499
1.20	10.0	3	38	200196	200478
1.21	10.0	3	38	200165	200447
1.22	10.0	3	38	200181	200463
1.23	10.0	3	38	200161	200443
1.24	10.0	3	38	200221	200503
1.25	10.0	3	38	200197	200479
1.26	10.0	3	38	200206	200488
1.27	10.0	3	38	200203	200485
1.28	10.0	3	38	200218	200500
1.29	10.0	3	38	200222	200504
1.30	10.0	3	38	200153	200435
1.31	11.2	3	38	200188	200470
1.32	11.2	3	38	200176	200458
1.33	11.2	3	38	200162	200444
1.34	11.2	3	38	200202	200484
1.35	11.2	3	38	200198	200480
1.36	11.2	3	38	200205	200487
1.37	11.2	3	38	200158	200440
1.38	11.2	3	38	200223	200505
1.39	11.2	3	38	200224	200506
1.40	11.2	3	38	200154	200436
1.45	11.2	3	38	200199	200481
1.50	11.2	3	38	200200	200482
1.55	12.0	3	38	200170	200452
1.60	12.0	3	38	200171	200453
1.65	12.0	3	38	200172	200454
1.70	12.0	3	38	200155	200437
1.75	12.0	3	38	200173	200455
1.80	12.0	3	38	200159	200441
1.85	12.0	3	38	200174	200456
1.90	12.0	3	38	200156	200438
1.95	12.0	3	38	200175	200457
2.00	12.0	3	38	960037	200517
2.05	15.0	3	38	960038	200518
2.10	15.0	3	38	960039	200519
2.15	15.0	3	38	960040	200520
2.20	15.0	3	38	960041	200521
2.25	15.0	3	38	960042	200522
2.30	15.0	3	38	960043	200523
2.35	15.0	3	38	960044	200524
2.40	15.0	3	38	960045	200525
2.45	15.0	3	38	960046	200526
2.50	15.0	3	38	960047	200527
2.55	15.0	3	38	960048	200528
2.80	16.0	3	38	960049	200529



P. 63



P. 74



$D_1 \geq 0.5$

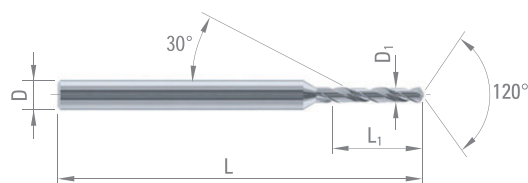
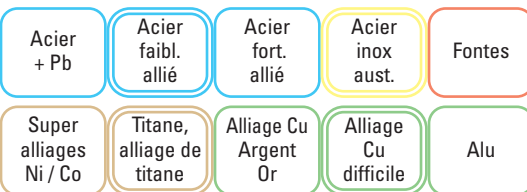

DIXI 1139

FORETS HÉLICOÏDAUX CORPS RENFORCÉ

Z = 2



P. 63



P. 74

$$L_1 = 12 \times D_1$$

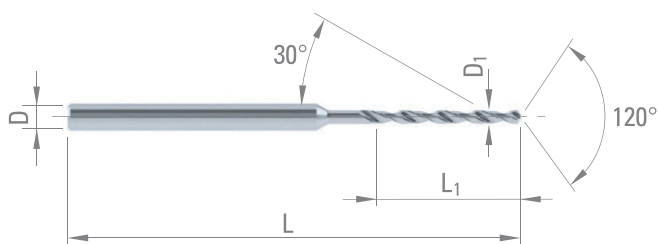

Acier + Pb	Acier faibl. allié	Aciers fort. allié	Acier inox aust.	Fontes
Super alliages Ni / Co	Titane, alliage de titane	Alliage Cu Argent Or	Alliage Cu difficile	Alu

D ₁ 0/-0.004	L ₁	D _{h5}	L	CARBURE	TiAIN
0.50	6.00	3	38	317729	317900
0.51	6.10	3	38	317730	317901
0.52	6.30	3	38	317731	317902
0.53	6.40	3	38	317732	317903
0.54	6.50	3	38	317733	317904
0.55	6.60	3	38	317734	317905
0.56	6.70	3	38	317735	317906
0.57	6.90	3	38	317736	317907
0.58	7.00	3	38	317737	317908
0.59	7.10	3	38	317738	317909
0.60	7.20	3	38	317739	317910
0.61	7.30	3	38	317740	317911
0.62	7.50	3	38	317741	317912
0.63	7.60	3	38	317742	317913
0.64	7.70	3	38	317743	317914
0.65	7.80	3	38	317744	317915
0.66	7.90	3	38	317745	317916
0.67	8.10	3	38	317746	317917
0.68	8.20	3	38	317747	317918
0.69	8.30	3	38	317748	317919
0.70	8.40	3	38	317749	317920
0.71	8.50	3	38	317750	317921
0.72	8.70	3	38	317751	317922
0.73	8.80	3	38	317752	317923
0.74	8.90	3	38	317753	317924
0.75	9.00	3	38	317754	317925
0.76	9.10	3	38	317755	317926
0.77	9.30	3	38	317756	317927
0.78	9.40	3	38	317757	317928
0.79	9.50	3	38	317758	317929
0.80	9.60	3	38	317759	317930
0.81	9.70	3	38	317760	317931
0.82	9.90	3	38	317761	317932
0.83	10.00	3	38	317762	317933
0.84	10.10	3	38	317763	317934
0.85	10.20	3	38	317764	317935
0.86	10.30	3	38	317765	317936
0.87	10.50	3	38	317766	317937
0.88	10.60	3	38	317767	317938
0.89	10.70	3	38	317768	317939
0.90	10.80	3	38	317769	317940
0.91	10.90	3	38	317770	317941
0.92	11.10	3	38	317771	317942
0.93	11.20	3	38	317772	317943
0.94	11.30	3	38	317773	317944

D ₁ 0/-0.004	L ₁	D _{h5}	L	CARBURE	TiAIN
0.95	11.40	3.0	38	317774	317945
0.96	11.50	3.0	38	317775	317946
0.97	11.70	3.0	38	317776	317947
0.98	11.80	3.0	38	317777	317948
0.99	11.90	3.0	38	317778	317949
1.00	12.00	3.0	38	317779	317950
1.01	12.10	3.0	38	317780	317951
1.02	12.30	3.0	38	317781	317952
1.03	12.40	3.0	38	317782	317953
1.04	12.50	3.0	38	317783	317954
1.05	12.60	3.0	38	317784	317955
1.06	12.70	3.0	38	317785	317956
1.07	12.90	3.0	38	317786	317957
1.08	13.00	3.0	38	317787	317958
1.09	13.10	3.0	38	317788	317959
1.10	13.20	3.0	38	317789	317960
1.11	13.30	3.0	38	317790	317961
1.12	13.50	3.0	38	317791	317962
1.13	13.60	3.0	38	317792	317963
1.14	13.70	3.0	38	317793	317964
1.15	13.80	3.0	38	317794	317965
1.16	13.90	3.0	38	317795	317966
1.17	14.10	3.0	38	317796	317967
1.18	14.20	3.0	38	317797	317968
1.19	14.30	3.0	38	317798	317969
1.20	14.40	3.0	38	317799	317970
1.21	14.50	3.0	38	317800	317971
1.22	14.70	3.0	38	317801	317972
1.23	14.80	3.0	38	317802	317973
1.24	14.90	3.0	38	317803	317974
1.25	15.00	3.0	38	317804	317975
1.26	15.10	3.0	50	317805	317976
1.27	15.30	3.0	50	317806	317977
1.28	15.40	3.0	50	317807	317978
1.29	15.50	3.0	50	317808	317979
1.30	15.60	3.0	50	317809	317980
1.31	15.70	3.0	50	317810	317981
1.32	15.90	3.0	50	317811	317982
1.33	16.00	3.0	50	317812	317983
1.34	16.10	3.0	50	317813	317984
1.35	16.20	3.0	50	317814	317985
1.36	16.30	3.0	50	317815	317986





P. 63



P. 74

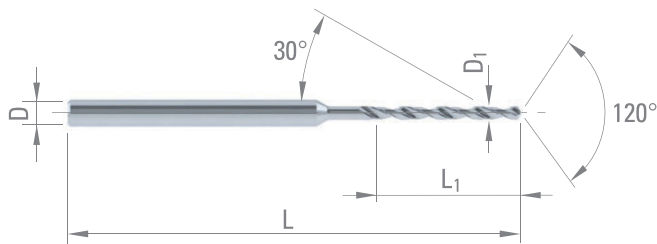

Acier + Pb	Acier faibl. allié	Aciers fort. allié	Acier inox aust.	Fontes
Super alliages Ni / Co	Titane, alliage de titane	Alliage Cu Argent Or	Alliage Cu difficile	Alu

D ₁ 0/-0.004	L ₁	D _{h5}	L	CARBURE	TiAIN
1.37	16.50	3.0	50	317816	317987
1.38	16.60	3.0	50	317817	317988
1.39	16.70	3.0	50	317818	317989
1.40	16.80	3.0	50	317819	317990
1.41	16.90	3.0	50	317820	317991
1.42	17.10	3.0	50	317821	317992
1.43	17.20	3.0	50	317822	317993
1.44	17.30	3.0	50	317823	317994
1.45	17.40	3.0	50	317824	317995
1.46	17.50	3.0	50	317825	317996
1.47	17.70	3.0	50	317826	317997
1.48	17.80	3.0	50	317827	317998
1.49	17.90	3.0	50	317828	317999
1.50	18.00	3.0	50	317829	318000
1.51	18.10	3.0	50	317830	318001
1.52	18.30	3.0	50	317831	318002
1.53	18.40	3.0	50	317832	318003
1.54	18.50	3.0	50	317833	318004
1.55	18.60	3.0	50	317834	318005
1.56	18.70	3.0	50	317835	318006
1.57	18.90	3.0	50	317836	318007
1.58	19.00	3.0	50	317837	318008
1.59	19.10	3.0	50	317838	318009
1.60	19.20	3.0	50	317839	318010
1.61	19.30	3.	50	317840	318011
1.62	19.40	3.0	50	317841	318012
1.63	19.60	3.0	50	317842	318013
1.64	19.70	3.0	50	317843	318014
1.65	19.80	3.0	50	317844	318015
1.66	19.90	3.0	50	317845	318016
1.67	20.10	3.0	50	317846	318017
1.68	20.20	3.0	50	317847	318018
1.69	20.30	3.0	50	317848	318019
1.70	20.40	3.0	50	317849	318020
1.71	20.50	3.0	50	317850	318021
1.72	20.70	3.0	50	317851	318022
1.73	20.80	3.0	50	317852	318023
1.74	20.90	3.0	50	317853	318024
1.75	21.00	3.0	50	317854	318025
1.76	21.10	3.0	50	317855	318026
1.77	21.30	3.0	50	317856	318027
1.78	21.40	3.0	50	317857	318028
1.79	21.50	3.0	50	317858	318029

D ₁ 0/-0.004	L ₁	D _{h5}	L	CARBURE	TiAIN
1.80	21.60	3.0	50	317859	318030
1.81	21.70	3.0	50	317860	318031
1.82	21.90	3.0	50	317861	318032
1.83	22.00	3.0	50	317862	318033
1.84	22.10	3.0	50	317863	318034
1.85	22.20	3.0	50	317864	318035
1.86	22.30	3.0	50	317865	318036
1.87	22.50	3.0	50	317866	318037
1.88	22.60	3.0	50	317867	318038
1.89	22.70	3.0	50	317868	318039
1.90	22.80	3.0	50	317869	318040
1.91	22.90	3.0	50	317870	318041
1.92	23.10	3.0	50	317871	318042
1.93	23.20	3.0	50	317872	318043
1.94	23.30	3.0	50	317873	318044
1.95	23.40	3.0	50	317874	318045
1.96	23.50	3.0	50	317875	318046
1.97	23.70	3.0	50	317876	318047
1.98	23.80	3.0	50	317877	318048
1.99	23.90	3.0	50	317878	318049
2.00	24.00	3.0	61	317879	318050
2.05	24.60	3.0	61	317880	318051
2.10	25.20	3.0	61	317881	318052
2.15	25.80	3.0	61	317882	318053
2.20	26.40	3.0	61	317883	318054
2.25	27.00	3.0	61	317884	318055
2.30	27.60	3.0	61	317885	318056
2.35	28.20	3.0	61	317886	318057
2.40	28.80	3.0	61	317887	318058
2.45	29.40	3.0	61	317888	318059
2.50	30.00	3.0	61	317889	318060
2.55	30.60	3.0	61	317890	318061
2.60	31.20	3.0	61	317891	318062
2.65	31.80	3.0	61	317892	318063
2.70	32.40	3.0	61	317893	318064
2.75	33.00	3.0	61	317894	318065
2.80	33.60	3.0	61	317895	318066
2.85	34.20	3.0	61	317896	318067
2.90	34.80	3.0	61	317897	318068
2.95	35.40	3.0	61	317898	318069
3.00	36.00	3.0	61	317899	318070



DIXI 1149 TiAIN

FORETS HÉLICOÏDAUX AUTO-CENTRANTS
CORPS RENFORCÉ

Z = 2



P. 63



P. 78

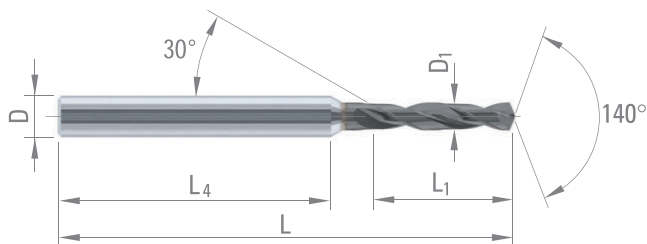

Acier + Pb	Acier faibl. allié	Acier fort. allié	Acier inox aust.	Fontes
Super alliages Ni / Co	Titane, alliage de titane	Alliage Cu difficile	Alu	

D ₁ h6	L ₁	L ₄	D _{h5}	L	TiAIN
1.00	5	26	3	38	976857
1.10	5	26	3	38	976858
1.20	5	26	3	38	976859
1.30	5	26	3	38	976860
1.40	5	26	3	38	976861
1.50	7	25	3	38	976862
1.60	7	25	3	38	976863
1.70	7	25	3	38	976864
1.80	7	25	3	38	976865
1.90	7	25	3	38	976866
2.00	9	35	3	50	43300
2.10	9	35	3	50	43301
2.20	9	35	3	50	43302
2.30	9	35	3	50	43303
2.40	9	35	3	50	43304
2.50	9	36	3	50	43305
2.60	11	31	4	50	43306
2.70	11	31	4	50	43307
2.80	11	31	4	50	41777
2.90	11	31	4	50	43308
3.00	14	39	6	62	43309
3.10	14	39	6	62	43310
3.175	14	39	6	62	64419
3.20	14	39	6	62	43311
3.30	14	39	6	62	43312
3.40	14	39	6	62	43313
3.50	14	39	6	62	43314
3.60	14	39	6	62	43315
3.70	14	40	6	62	43316
3.80	17	40	6	66	43317
3.90	17	40	6	66	43318
4.00	17	40	6	66	43319
4.10	17	40	6	66	43320
4.20	17	40	6	66	43321
4.30	17	40	6	66	43322
4.40	17	40	6	66	43323
4.50	17	40	6	66	43324
4.60	17	40	6	66	43325
4.70	17	40	6	66	43326



DIXI 1149 TiAIN

D_{1h6}	L_1	L_4	D_{h5}	L	TiAIN
4.762	20	37	6	66	43673
4.80	20	37	6	66	43327
4.90	20	38	6	66	43328
5.00	20	38	6	66	43329
5.10	20	38	6	66	966749
5.20	20	38	6	66	43330
5.30	20	38	6	66	43331
5.40	20	38	6	66	966750
5.50	20	38	6	66	43332
5.60	22	37	6	66	960752
5.70	22	37	6	66	966751
5.80	22	37	6	66	43333
5.90	22	37	6	66	966752
6.00	22	37	6	66	43334
6.20	24	43	8	79	43447
6.30	24	43	8	79	43538
6.35	24	43	8	79	44585
6.40	24	43	8	79	63641
6.50	24	43	8	79	39394
6.60	24	43	8	79	43539
6.70	24	43	8	79	966756
6.80	24	44	8	79	43540
6.90	24	44	8	79	966757
7.00	24	43	8	79	43541
7.20	29	38	8	79	56826
7.50	29	38	8	79	43542
7.80	29	38	8	79	43543
8.00	29	39	8	79	43544
8.20	35	40	10	89	43448
8.40	35	40	10	89	55450
8.50	35	40	10	89	42654
8.70	35	41	10	89	54604
8.80	35	41	10	89	56828
9.00	35	41	10	89	43545
9.20	35	41	10	89	55451
9.50	35	41	10	89	43546
9.80	35	41	10	89	43547
10.00	35	42	10	89	43548
10.10	40	47	12	102	978563
10.20	40	47	12	102	43549
10.50	40	47	12	102	43550
10.80	40	48	12	102	59472
11.00	40	48	12	102	43551
11.50	41	47	12	102	43552
12.00	42	47	12	102	43553
13.00	46	47	14	107	43554
14.00	49	45	14	107	43556



P. 63



P. 78

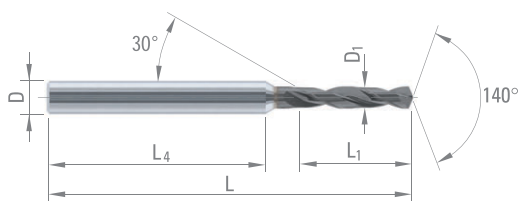
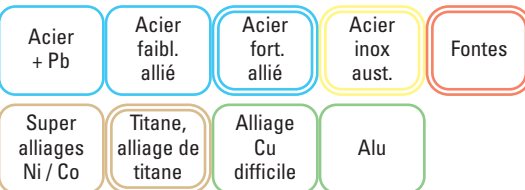

DIXI 1147 TiAIN

FORETS HÉLICOÏDAUX AUTO-CENTRANTS
CORPS RENFORCÉ

Z = 2



P. 63



P. 80



$$L_1 = 6.5 \times D_1$$

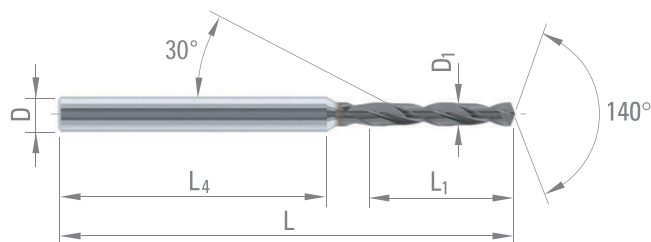

Acier + Pb	Acier faibl. allié	Acier fort. allié	Acier inox aust.	Fontes
Super alliages Ni / Co	Titane, alliage de titane	Alu		

D ₁ h6	L ₁	L ₄	D _{h5}	L	TiAIN
0.50	3.3	29	3	38	960468
0.55	3.6	29	3	38	960469
0.60	3.9	29	3	38	960470
0.65	4.2	33	3	43	960471
0.70	4.6	33	3	43	960472
0.75	4.9	33	3	43	960473
0.80	5.2	32	3	43	960474
0.85	5.5	32	3	43	960475
0.90	5.9	32	3	43	960476
0.95	6.2	32	3	43	960477
1.00	6.5	31	3	43	960478
1.10	7.2	31	3	43	960479
1.20	7.8	37	3	50	960480
1.30	8.5	37	3	50	960481
1.40	9.1	36	3	50	960482
1.50	9.8	35	3	50	960483
1.60	10.4	35	3	50	960484
1.70	11.1	34	3	50	960485
1.80	11.7	34	3	50	960486
1.90	12.4	33	3	50	960487
2.00	13.0	43	4	62	960137
2.10	13.7	42	4	62	960138
2.20	14.3	42	4	62	960139
2.30	15.0	41	4	62	960140
2.40	15.6	41	4	62	960141
2.50	16.3	40	4	62	960142
2.60	16.9	39	4	62	960143
2.70	17.6	39	4	62	960144
2.80	18.2	38	4	62	960145
2.90	18.9	38	4	62	960146
3.00	19.5	37	4	62	960147
3.10	20.2	53	6	79	960148
3.20	20.8	52	6	79	960149
3.30	21.5	51	6	79	960150
3.40	22.1	51	6	79	960151
3.50	22.8	50	6	79	960152
3.60	23.4	50	6	79	966741
3.75	24.4	49	6	79	960153
3.80	24.7	48	6	79	960154
3.90	25.4	47	6	79	961304



DIXI 1147 TiAlN

$D_{1\ h6}$	L_1	L_4	D_{h5}	L	TiAlN
4.00	26.0	47	6	79	960155
4.10	26.7	46	6	79	960156
4.20	27.3	45	6	79	960157
4.30	28.0	45	6	79	960158
4.40	28.6	44	6	79	959769
4.50	29.3	43	6	79	960159
4.60	29.9	43	6	79	960160
4.70	30.6	42	6	79	960161
4.80	31.2	42	6	79	960162
4.90	31.9	41	6	79	960163
5.00	32.5	50	6	89	959770
5.10	33.2	49	6	89	960167
5.20	33.8	49	6	89	960169
5.30	33.5	48	6	89	960170
5.40	35.1	48	6	89	966742
5.50	35.8	47	6	89	960171
5.60	36.4	46	6	89	960172
5.70	37.1	46	6	89	966743
5.80	37.7	45	6	89	960173
5.90	38.4	44	6	89	966744
6.00	39.0	44	6	89	960174
6.10	39.7	54	8	102	960175
6.20	40.3	53	8	102	960176
6.30	41.0	53	8	102	960177
6.35	41.3	53	8	102	960178
6.40	41.6	52	8	102	966745
6.50	42.3	51	8	102	960179
6.60	42.9	51	8	102	960180
6.70	43.6	50	8	102	966747
6.80	44.2	50	8	102	960181
6.90	44.9	49	8	102	966748
7.00	45.5	48	8	102	960182
7.20	46.8	47	8	102	960183
7.50	48.8	45	8	102	960184
7.80	50.7	43	8	102	960185
8.00	52.0	42	8	102	960186
8.20	53.3	54	10	118	960187
8.40	54.0	54	10	118	960188
8.50	55.3	52	10	118	960189
8.80	57.2	51	10	118	960190
9.00	58.5	49	10	118	960191
9.50	61.8	46	10	118	960192
9.80	63.7	44	10	118	960193
10.00	65.0	43	10	118	960194



P. 63



P. 80

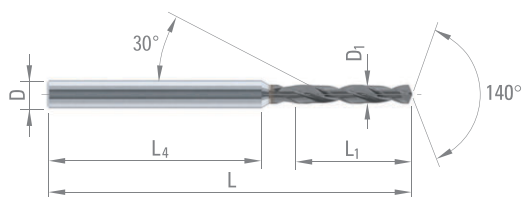
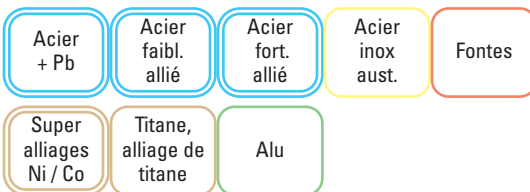

DIXI 1145-HH TiAIN

FORETS HÉLICOÏDAUX AUTO-CENTRANTS À TROUS DE LUBRIFICATION

Z = 2



P. 63



P. 78

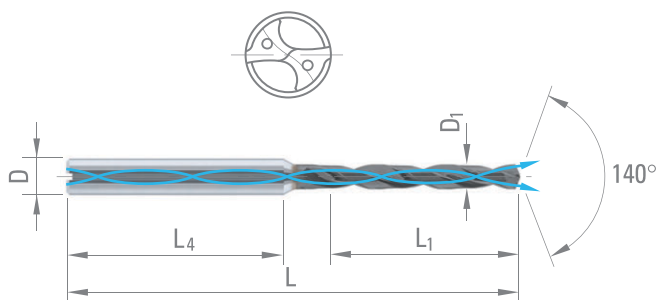

Acier + Pb	Acier faibl. allié	Acier fort. allié	Acier inox aust.	Fontes
Super alliages Ni / Co	Titane, alliage de titane	Alliage Cu difficile	Alu	

D ₁ h6	L ₁	L ₄	D _{h5}	L	TiAIN
0.70	5	26	3	38	956705
0.80	5	26	3	38	954321
1.40	7	25	3	38	956694
1.50	11	20	3	38	956692
1.60	11	20	3	38	956690
1.70	11	20	3	38	956688
1.80	11	20	3	38	956686
1.90	11	20	3	38	956683
2.00	15	18	3	38	954320
2.10	15	18	3	38	956325
2.20	15	18	3	38	956326
2.30	15	26	4	50	956327
2.40	15	27	4	50	956328
2.50	18	24	4	50	956329
2.60	18	24	4	50	956330
2.70	18	24	4	50	956331
2.80	18	24	4	50	956332
2.90	23	35	6	66	956333
3.00	23	35	6	66	65470
3.10	23	35	6	66	953836
3.20	23	35	6	66	953835
3.30	23	35	6	66	65471
3.40	23	35	6	66	953837
3.50	23	35	6	66	65472
3.60	29	35	6	74	966718
3.70	29	35	6	74	966719
3.75	29	36	6	74	65473
3.80	29	36	6	74	953838
3.90	29	36	6	74	966720
4.00	29	36	6	74	45540
4.10	29	36	6	74	953839
4.20	29	36	6	74	56829
4.30	29	36	6	74	62995
4.40	29	36	6	74	956579
4.50	35	38	6	82	953840
4.60	35	38	6	82	966721
4.70	35	38	6	82	966722
4.80	35	38	6	82	45541
4.90	35	38	6	82	966826



DIXI 1145-HH TiAIN

D _{1 h6}	L ₁	L ₄	D _{h5}	L	TiAIN
5.00	35	39	6	82	43272
5.10	35	39	6	82	953841
5.20	35	39	6	82	56830
5.30	35	39	6	82	59465
5.40	35	39	6	82	953842
5.50	35	39	6	82	45542
5.60	35	39	6	82	954509
5.70	35	39	6	82	966723
5.80	35	39	6	82	59466
5.90	35	39	6	82	966724
6.00	35	40	6	82	38821
6.10	43	36	8	91	953843
6.20	43	36	8	91	56831
6.30	43	36	8	91	43279
6.35	43	36	8	91	59467
6.40	43	36	8	91	953844
6.50	43	36	8	91	39758
6.60	43	36	8	91	59468
6.70	43	36	8	91	956886
6.80	43	36	8	91	45614
6.90	43	36	8	91	966725
7.00	43	36	8	91	43283
7.20	43	36	8	91	56833
7.30	43	36	8	91	954510
7.40	43	36	8	91	59384
7.50	43	36	8	91	43284
7.60	43	36	8	91	954511
7.80	43	36	8	91	43285
8.00	43	-	8	91	39530
8.10	49	40	10	103	954512
8.20	49	40	10	103	56834
8.30	49	40	10	103	954513
8.40	49	40	10	103	59469
8.50	49	40	10	103	52633
8.60	49	40	10	103	954514
8.80	49	40	10	103	45615
9.00	49	41	10	103	43288
9.20	49	41	10	103	953849
9.40	49	41	10	103	954515
9.50	49	41	10	103	63430
9.60	49	41	10	103	954516
9.70	49	41	10	103	953846
9.80	49	41	10	103	44777
10.00	49	-	10	103	40751
10.10	56	47	12	118	954326
10.20	56	47	12	118	56837
10.30	56	47	12	118	954518
10.50	56	47	12	118	44152
10.60	56	47	12	118	954517
10.80	56	47	12	118	45616
11.00	56	48	12	118	43294
11.30	58	46	12	118	954519
11.50	58	46	12	118	45207
12.00	60	45	12	118	40752
13.00	65	45	14	124	44339
14.00	70	-	14	124	45649



P. 63



P. 78

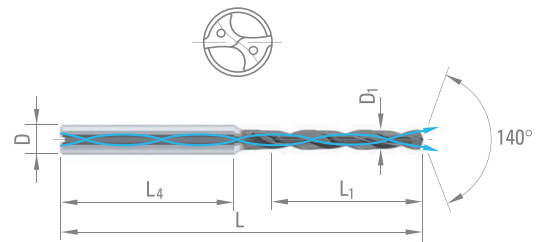
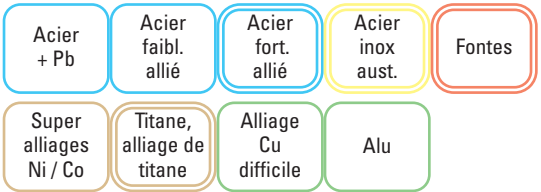

DIXI 1146-HH TiAIN

FORETS HÉLICOÏDAUX AUTO-CENTRANTS
À TROUS DE LUBRIFICATION

Z = 2



P. 63



P. 80



$$L_1 = 10 \times D_1$$

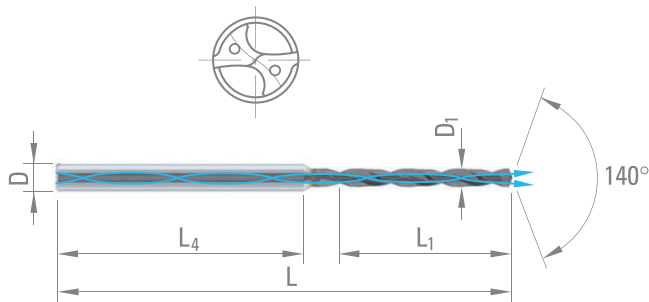

Acier + Pb	Acier faibl. allié	Acier fort. allié	Acier inox aust.	Fontes
Super alliages Ni / Co	Titane, alliage de titane	Alu		

$D_{1\ h6}$	L_1	L_4	D_{h5}	L	TiAIN
0.80	8.0	37	3	50	960206
0.85	8.5	37	3	50	960208
0.90	9.0	36	3	50	960209
0.95	9.5	36	3	50	960210
1.00	10.0	35	3	50	960211
1.10	11.0	34	3	50	960212
1.20	12.0	33	3	50	960214
1.30	13.0	33	3	50	960215
1.40	14.0	32	3	50	960216
1.50	15.0	43	3	62	960217
1.60	16.0	42	3	62	960218
1.70	17.0	41	3	62	960219
1.80	18.0	40	3	62	960220
1.90	19.0	39	3	62	960221
2.00	20.0	38	3	62	960222
2.10	21.0	37	3	62	960223
2.20	22.0	36	3	62	960224
2.30	23.0	51	4	79	960225
2.40	24.0	50	4	79	960226
2.50	25.0	49	4	79	960227
2.60	26.0	48	4	79	960228
2.70	27.0	47	4	79	960229
2.80	28.0	46	4	79	960230
2.90	29.0	44	6	79	960231
3.00	30.0	43	6	79	960232
3.10	31.0	52	6	89	966726
3.20	32.0	51	6	89	966727
3.30	33.0	50	6	89	960243
3.40	34.0	49	6	89	966728
3.50	35.0	48	6	89	960244
3.60	36.0	47	6	89	966729
3.75	37.5	46	6	89	960245
3.90	39.0	44	6	89	966730
4.00	40.0	56	6	102	960246
4.10	41.0	55	6	102	966731
4.20	42.0	54	6	102	960247
4.30	43.0	53	6	102	960248
4.40	44.0	52	6	102	966732
4.50	45.0	51	6	102	960249



DIXI 1146-HH TiAIN

$D_{1\ h6}$	L_1	L_4	D_{h5}	L	TiAIN
4.60	46.0	50	6	102	966733
4.70	47.0	49	6	102	966734
4.80	48.0	48	6	102	960250
4.90	49.0	47	6	102	966735
5.00	50.0	46	6	102	960251
5.10	51.0	45	6	102	966736
5.20	52.0	44	6	102	960252
5.30	53.0	43	6	102	960253
5.40	54.0	42	6	102	966737
5.50	55.0	41	6	102	960254
5.60	56.0	56	6	118	966738
5.70	57.0	55	6	118	966739
5.80	58.0	54	6	118	960255
5.90	59.0	53	6	118	963660
6.00	60.0	52	6	118	960256
6.10	61.0	49	8	118	966740
6.20	62.0	48	8	118	960257
6.30	63.0	47	8	118	960426
6.35	63.5	47	8	118	960427
6.50	65.0	45	8	118	960428
6.60	66.0	59	8	133	960429
6.80	68.0	57	8	133	960430
6.90	69.0	56	8	133	963661
7.00	70.0	55	8	133	960431
7.20	72.0	53	8	133	960432
7.50	75.0	50	8	133	960433
7.80	78.0	47	8	133	960434
8.00	80.0	45	8	133	960435
8.20	82.0	59	10	151	960436
8.40	84.0	57	10	151	960437
8.50	85.0	56	10	151	960438
8.80	88.0	53	10	151	960439
9.00	90.0	60	10	160	960440
9.20	92.0	58	10	160	960441
9.40	94.0	56	10	160	960442
9.525	95.3	55	10	160	960443
9.80	98.0	52	10	160	960444
10.00	100.0	50	10	160	960445



P. 63



P. 80

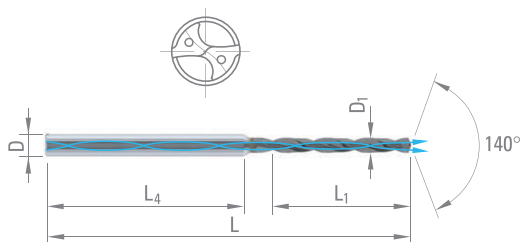
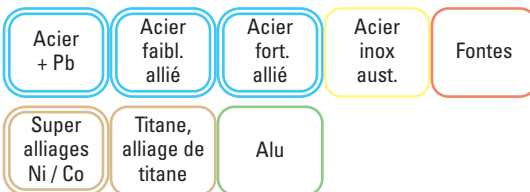

DIXI 1280 XIDUR

FORETS HÉLICOÏDAUX POUR ACIERS DURS
CORPS RENFORCÉ

Z = 2



P. 63



P. 82



$\emptyset 0.25 < \emptyset 2.50$

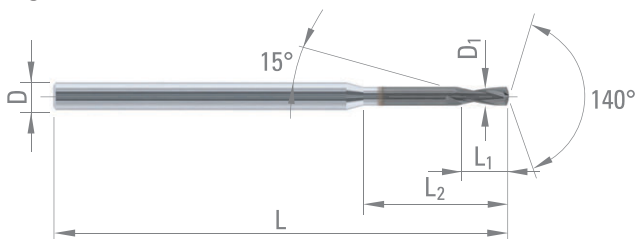

$\emptyset 2.50 \leq \emptyset 12.00$

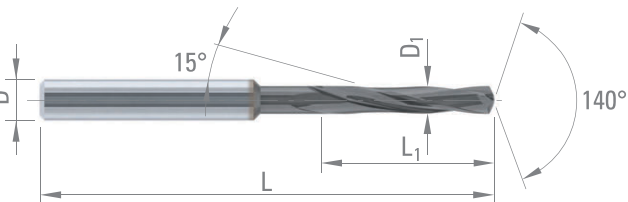

Acier
fort.
allié

Aciers
Fontes
45-65 HRC

Super
alliages
Ni / Co

$D_{1\ h6}$	L_1	L_2	D_{h5}	L	XIDUR
0.25	0.75	2.0	3	38	957466
0.30	0.90	2.5	3	38	956658
0.40	1.20	3.2	3	38	956659
0.50	1.50	4.0	3	38	956660
0.60	1.80	4.8	3	38	956661
0.70	2.10	5.6	3	38	956662
0.80	2.40	6.5	3	38	956663
0.90	2.70	7.5	3	38	956664
1.00	3.00	8.0	3	38	956665
1.10	3.30	8.0	3	50	957524
1.20	3.60	10.0	3	50	956666
1.30	3.90	12.0	3	50	957525
1.40	4.20	12.0	3	50	957467
1.50	4.50	12.0	3	50	956667
1.60	4.80	15.0	3	50	957526
1.70	5.10	15.0	3	50	957527
1.80	5.40	15.0	3	50	956668
1.90	5.80	15.0	3	50	957528
2.00	6.00	16.0	3	50	956669

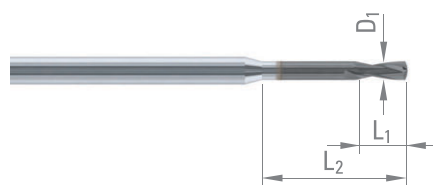

$D_{1\ h6}$	L_1	D_{h5}	L	XIDUR
2.50	15	3	62	62529
2.60	15	3	62	62843
2.70	15	3	62	62844
2.80	15	3	62	62845
2.90	15	3	62	62846
3.00	20	4	66	62530
3.175	20	4	66	62848
3.30	20	4	66	62849
3.40	20	4	66	62850
3.50	20	4	66	62531
3.57	20	4	66	62851
3.70	20	4	66	62852
3.80	20	4	66	62853
3.90	20	4	66	62854
4.00	30	6	66	62532
4.10	30	6	66	62855
4.20	30	6	66	62533
4.30	30	6	66	62857
4.365	30	6	66	62858
4.50	30	6	66	62859

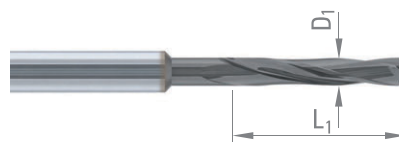

DIXI 1280 XIDUR

D_{1h6}	L_1	D_{h5}	L	XIDUR
4.60	30	6	66	62860
4.70	30	6	66	62861
4.762	30	6	66	62862
4.90	30	6	66	62863
5.00	30	6	66	62534
5.10	30	6	66	62414
5.16	30	6	66	62864
5.50	30	6	66	62867
5.80	30	6	66	62870
6.00	40	8	79	62872
6.35	40	8	79	62874
6.50	40	8	79	62877
6.80	40	8	79	62535
7.00	40	8	79	62878
7.50	40	8	79	62880
7.80	40	8	79	62881
8.00	50	10	89	62882
8.33	50	10	89	62883
8.50	50	10	89	62536
8.73	50	10	89	62884
9.00	50	10	89	62885
9.525	50	10	89	62886
9.80	50	10	89	62887
10.00	60	12	102	62888
10.20	60	12	102	62889
10.50	60	12	102	62890
10.80	60	12	102	62891
11.00	60	12	102	62895
11.50	60	12	102	62896
12.00	60	12	102	62897



P. 63



P. 82



Acier
fort.
allié

Aciers
Fontes
45-65 HRC

Super
alliages
Ni / Co

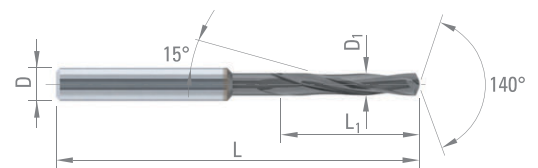



P. 63



P. 82

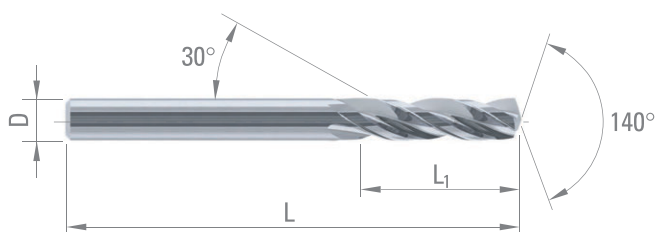

Acier + Pb

Acier faibl. allié

Fontes

Titane, alliage de titane

Alliage Cu Argent Or

Alu

D _{h5}	L ₁	L	CARBURE
1.00	8	30	31446
1.05	8	30	47890
1.10	10	30	31573
1.15	10	30	37288
1.20	10	30	31574
1.25	10	30	34553
1.30	10	30	31575
1.35	10	30	37506
1.40	10	30	31576
1.45	10	30	47039
1.50	10	30	31560
1.55	12	38	47891
1.60	12	38	31577
1.63	12	38	41603
1.64	12	38	58867
1.65	12	38	38467
1.70	12	38	31578
1.75	12	38	43738
1.80	12	38	31579
1.85	12	38	47899
1.90	12	38	31294
1.95	12	38	47040
2.00	12	38	31580
2.04	12	38	954146
2.10	12	38	31581
2.20	13	40	41993
2.30	13	40	31583
2.40	14	43	39320
2.50	14	43	41454
2.60	14	43	42140
2.70	16	46	31295
2.80	16	46	31296
2.90	16	46	31586
3.00	16	46	29106
3.10	18	49	31197
3.20	18	49	31728
3.30	18	49	29107
3.40	20	52	33271
3.50	20	52	29108



DIXI 1151

D _{h5}	L ₁	L	CARBURE
3.60	20	52	31297
3.70	20	52	32311
3.80	22	55	29109
3.90	22	55	42942
4.00	22	55	42305
4.10	22	55	42939
4.20	22	55	29111
4.30	24	58	32871
4.40	24	58	33427
4.50	24	58	29112
4.60	24	58	32862
4.70	24	58	32312
4.80	26	62	29113
4.90	26	62	31590
5.00	26	62	29114
5.10	26	62	41455
5.20	26	62	32639
5.30	26	62	31717
5.40	28	66	34791
5.50	28	66	29115
5.60	28	66	41597
5.70	28	66	32313
5.80	28	66	43809
5.90	28	66	45905
6.00	28	66	41120
6.10	31	70	41620
6.20	31	70	32640
6.30	31	70	34792
6.40	31	70	33105
6.50	31	70	29118
6.60	31	70	34754
6.70	31	70	31506
6.80	34	74	29119
6.90	34	74	32860
7.00	34	74	29120
7.50	34	74	29121
7.80	37	79	29122
8.00	37	79	43769
8.20	37	79	32237
8.50	37	79	41927
8.80	40	84	29125
9.00	40	84	29126
9.50	40	84	29127
9.80	43	89	29128
10.00	43	89	29129
10.20	43	89	29130
10.50	43	89	29131
11.00	47	95	29132
11.50	47	95	29133
12.00	51	102	29134
12.50	51	102	32641
13.00	51	102	29135
13.50	54	107	32642
14.00	54	107	29136

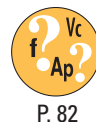

Acier + Pb

Acier faibl. allié

Fontes

Titane, alliage de titane

Alliage Cu Argent Or

Alu

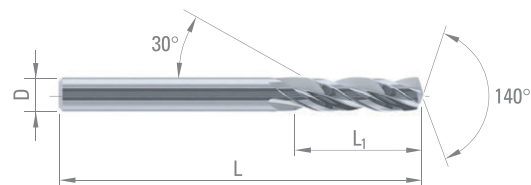

DIXI 1152

FORETS ALÉSEURS CORPS RENFORCÉ

Z = 3



P. 63

P. 82

$\emptyset 0.15 < \emptyset 0.50$

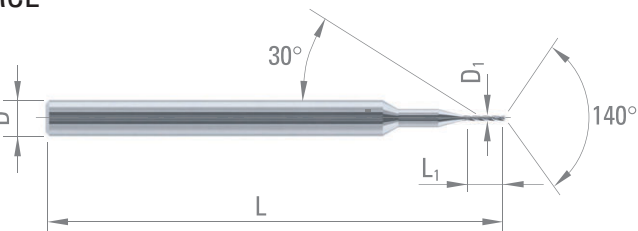

$\emptyset 0.50 \leq \emptyset 2.90$

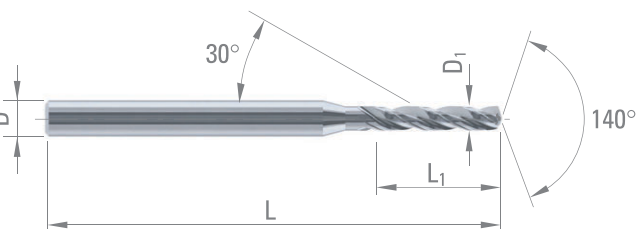

$D_{10/-0.004}$	L_1	D_2	L_2	D_{h5}	L	CARBURE
0.15	1.5	1.5	6.80	3	38	962817
0.20	1.5	1.5	6.80	3	38	962818
0.25	2.0	1.5	7.35	3	38	962819
0.30	2.0	1.5	7.35	3	38	962820
0.35	2.0	1.5	7.35	3	38	962821
0.40	2.0	1.5	7.35	3	38	962822
0.45	3.6	1.5	8.95	3	38	962850

$D_{10/-0.004}$	L_1	D_{h5}	L	CARBURE
0.50	4.0	3	38	962851
0.53	4.5	3	38	962852
0.55	4.5	3	38	962853
0.60	4.5	3	38	962854
0.62	5.0	3	38	962855
0.65	5.0	3	38	962856
0.70	5.6	3	38	962857
0.71	5.6	3	38	962858
0.75	5.6	3	38	962859
0.80	6.3	3	38	962860
0.81	6.3	3	38	962861
0.82	6.3	3	38	962862
0.83	6.3	3	38	962863
0.84	6.3	3	38	962864
0.85	6.3	3	38	962865
0.86	7.1	3	38	962866
0.87	7.1	3	38	962867
0.88	7.1	3	38	962868
0.89	7.1	3	38	962869
0.90	7.1	3	38	962870
0.91	7.1	3	38	962871
0.92	7.1	3	38	962872
0.93	7.1	3	38	962873
0.94	7.1	3	38	962874
0.95	7.1	3	38	962875
0.96	9.0	3	38	962876
0.97	9.0	3	38	962877
0.98	9.0	3	38	962878
0.99	9.0	3	38	962879
1.00	9.0	3	38	962880
1.01	9.0	3	38	962881
1.02	9.0	3	38	962882
1.03	9.0	3	38	962883
1.04	9.0	3	38	962884
1.05	9.0	3	38	962885
1.06	9.0	3	38	962886
1.07	9.0	3	38	962887

Acier + Pb

Acier faibl. allié

Fontes

Titane, alliage de titane

Alliage Cu Argent Or

Alu

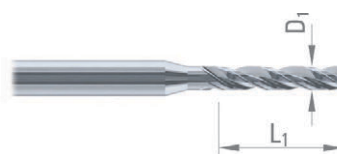
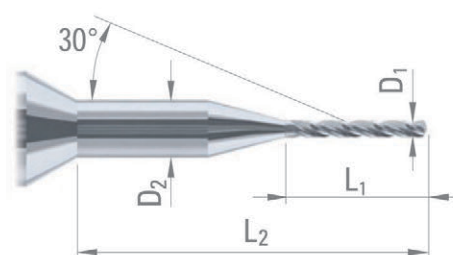

DIXI 1152

$D_{10/-0.004}$	L_1	D_{h5}	L	CARBURE
1.08	9.0	3	38	962888
1.09	9.0	3	38	962889
1.10	9.0	3	38	962890
1.11	9.0	3	38	962901
1.12	9.0	3	38	962902
1.13	9.0	3	38	962903
1.14	9.0	3	38	962904
1.15	9.0	3	38	962905
1.16	10.0	3	38	962906
1.17	10.0	3	38	962907
1.18	10.0	3	38	962908
1.19	10.0	3	38	962909
1.20	10.0	3	38	962910
1.21	10.0	3	38	962911
1.22	10.0	3	38	962912
1.23	10.0	3	38	962913
1.24	10.0	3	38	962914
1.25	10.0	3	38	962915
1.26	10.0	3	38	962916
1.27	10.0	3	38	962917
1.28	10.0	3	38	962918
1.29	10.0	3	38	962919
1.30	10.0	3	38	962920
1.31	11.2	3	38	962921
1.32	11.2	3	38	962922
1.33	11.2	3	38	962923
1.34	11.2	3	38	962925
1.35	11.2	3	38	962926
1.36	11.2	3	38	962927
1.37	11.2	3	38	962928
1.38	11.2	3	38	962930
1.39	11.2	3	38	962931
1.40	11.2	3	38	962932
1.45	11.2	3	38	962933
1.50	11.2	3	38	962934
1.55	12.0	3	38	962935
1.60	12.0	3	38	962936
1.65	12.0	3	38	962937
1.67	12.0	3	38	962959
1.70	12.0	3	38	962938
1.75	12.0	3	38	962940
1.80	12.0	3	38	962941
1.85	12.0	3	38	962942
1.90	12.0	3	38	962943
1.95	12.0	3	38	962944
2.00	12.0	3	38	962945
2.03	15.0	3	38	962960
2.04	15.0	3	38	962961
2.05	15.0	3	38	963109
2.10	15.0	3	38	963111
2.15	15.0	3	38	963115
2.20	15.0	3	38	963116
2.25	15.0	3	38	963117
2.30	15.0	3	38	963118
2.35	15.0	3	38	963119
2.40	15.0	3	38	963120
2.45	15.0	3	38	963121
2.50	15.0	3	38	963122
2.55	15.0	3	38	963123
2.60	15.0	3	38	963124
2.70	16.0	3	38	963125
2.80	16.0	3	38	963126
2.90	16.0	3	38	963127



P. 63



P. 82

Acier + Pb

Acier faibl. allié

Fontes

Titane, alliage de titane

Alliage Cu Argent Or

Alu

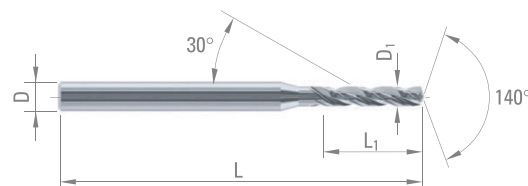

DIXI 1290

FORETS POUR MATIÈRES COMPOSITES /
KEVLAR®

Z = 2

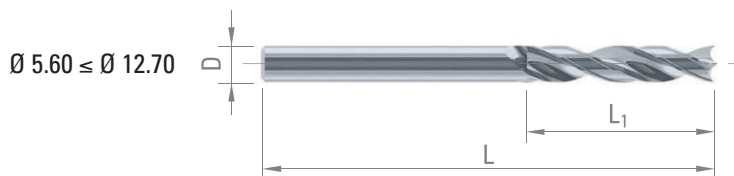

Kevlar®

Conditions de coupe: $V_c = 100 - 150 \text{ m/min}$
 $f = 0.05 - 0.15 \text{ mm/tr}$

D _{h5}	inches	L ₁	L	CARBURE
2.50		18	50	29322
3.00		18	50	26766
3.175	1/8"	18	50	27059
3.20		18	50	27948
3.30		18	50	28660
3.50		20	50	27949
3.80		20	50	26283
3.968	5/32"	22	50	27950
4.00		22	50	26767
4.10		22	50	29224
4.20		25	55	27951
4.50		25	58	27731
4.80		25	62	29324
5.00		25	62	29299
5.20		25	62	29072
5.50		25	66	27952
5.556	7/32"	25	60	26588

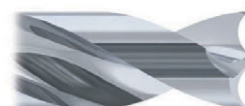

D _{h5}	inches	L ₁	L	CARBURE
5.60		30	66	29215
6.00		30	66	43244
6.35	1/4"	30	70	27199
6.50		30	70	28661
8.00		35	75	26663
9.00		35	75	27957
9.525	3/8"	35	75	27959
10.00		35	75	27684
11.00		50	100	29493
12.00		50	100	26723
12.70	1/2"	50	100	26661



DIXI 1112 R+L

FORETS PLATS

Ø 0.08 - 5.99

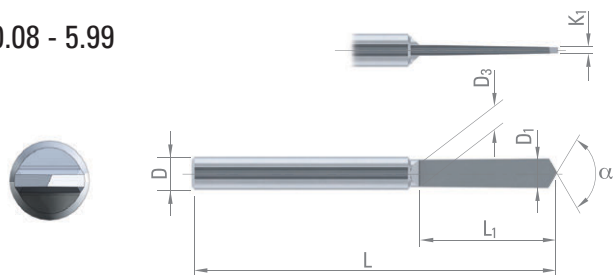

Z = 2



P. 66

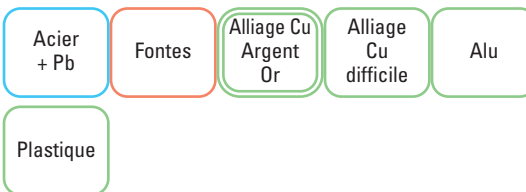

DIXI 1114 R+L

MÈCHES À CANON DEMI-LUNE
EXÉCUTION A OU B

Ø 0.08 - 5.99

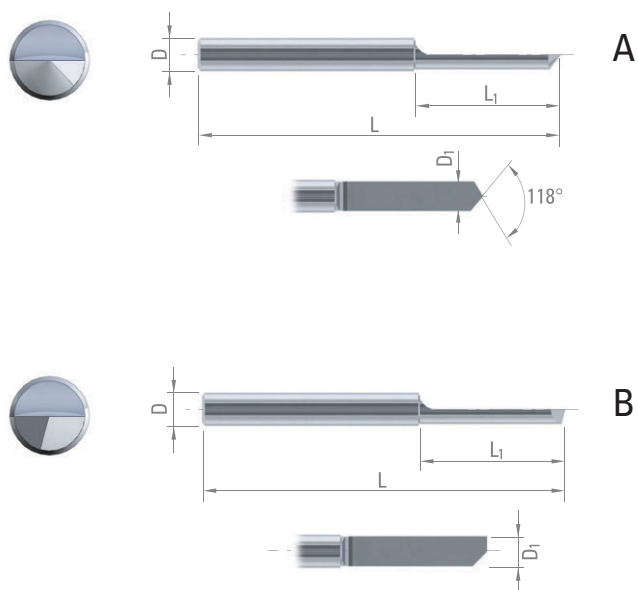

Z = 1

Valeurs indicatives pour définir les forets
DIXI 1112, 1114 et 1118.

$D_{10/-0.004}$	L_1	D_{h5}	L
0.08 - 0.14	0.7	1.0	30
0.15 - 0.29	1.0	1.0	30
0.30 - 0.39	1.5	1.0	30
0.40 - 0.44	2.0	1.0	30
0.45 - 0.48	3.6	1.0	30
0.49 - 0.53	4.0	1.0	30
0.54 - 0.60	4.5	1.0	30
0.61 - 0.67	5.0	1.0	30
0.68 - 0.75	5.6	1.0	30
0.76 - 0.79	6.3	1.0	30
0.80 - 0.85	6.3	1.5	30
0.86 - 0.95	7.1	1.5	30
0.96 - 0.99	8.0	1.5	30
1.00 - 1.18	9.0	1.5	30
1.19 - 1.32	10.0	1.5	30
1.33 - 1.49	11.2	1.5	30
1.50 - 1.99	12.0	2.0	38
2.00 - 2.49	12.0	2.5	43
2.50 - 2.99	15.0	3.0	46
3.00 - 3.49	18.0	3.5	50
3.50 - 3.99	18.0	4.0	50
4.00 - 4.49	20.0	4.5	50
4.50 - 4.99	22.0	5.0	50
5.00 - 5.49	25.0	5.5	50
5.50 - 5.99	25.0	6.0	50

DIXI 1118 R+L

FORETS DENTURE DROITE

Ø 0.08 - 5.99

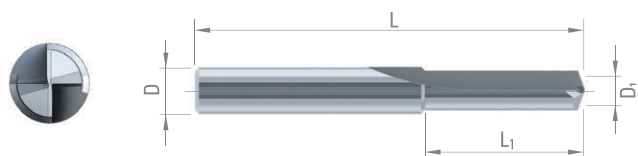

Z = 2





DESSINS POUR COMMANDES
DE FORETS ÉTAGÉS



P. 66
P. 84

DIXI 1501

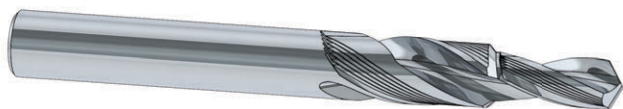

DIXI 1514 (Z = 1)



Angle d'hélice défini par la matière à usiner.

DIXI 1512 (Z = 2)

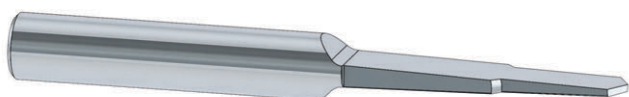

DIXI 1518 (Z = 2)



Sauf contre-indication, les tolérances et dimensions standard DIXI seront appliquées.

R L

Z =

Angle d'hélice

Quantités

Matière à usiner

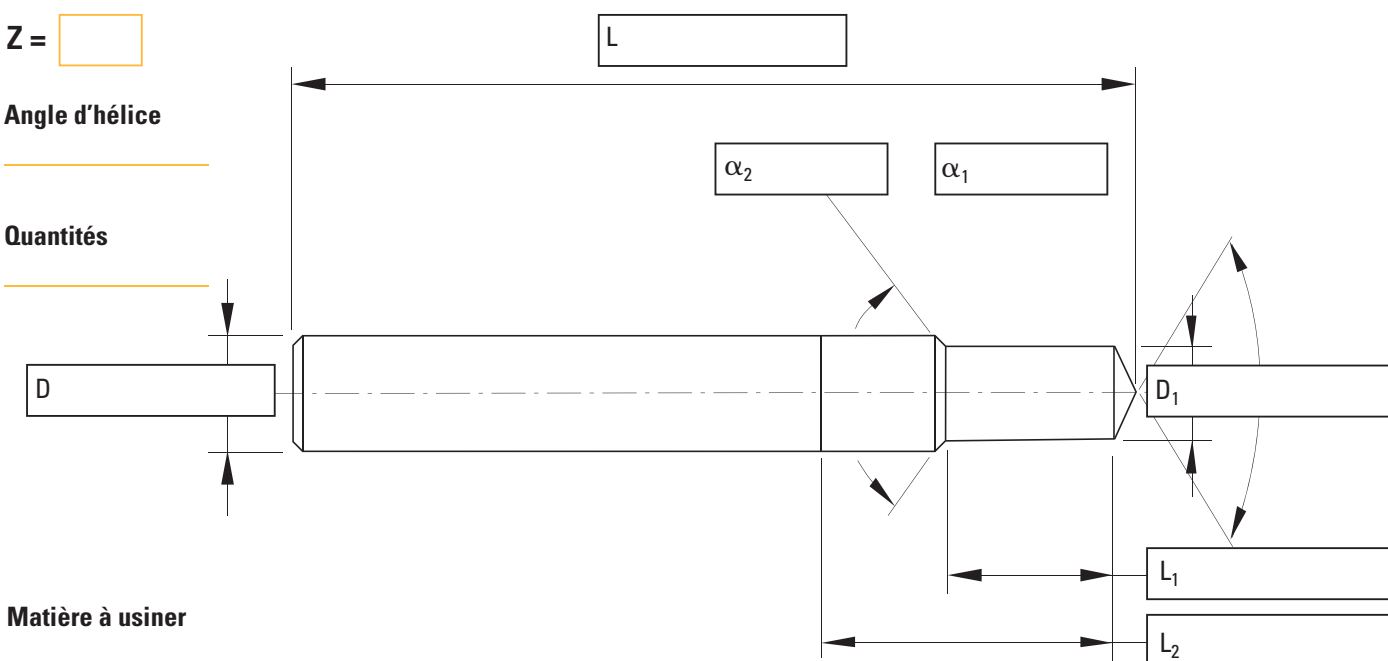

Remarques

CONSULTEZ NOTRE FORMULAIRE DE DEMANDE D'OFFRES EN LIGNE SUR
WWW.DIXIPOLYTOOL.COM





DESSINS POUR COMMANDES
DE FORETS ÉTAGÉS



P. 66
P. 84

DIXI 1502

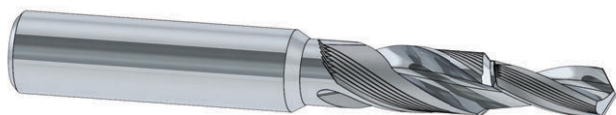

DIXI 1514 (Z = 1)

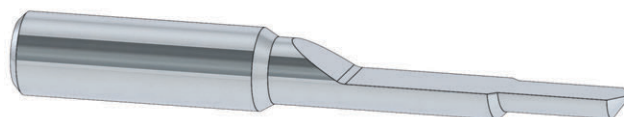

Angle d'hélice défini par la matière à usiner.

DIXI 1512 (Z = 2)

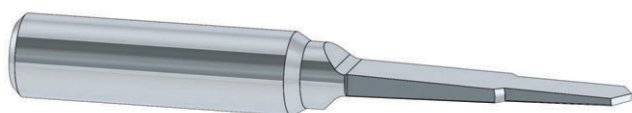

DIXI 1518 (Z = 2)

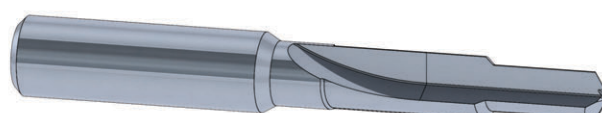

Sauf contre-indication, les tolérances et dimensions standard DIXI seront appliquées.

R L

Z =

Angle d'hélice

Quantités

Matière à usiner

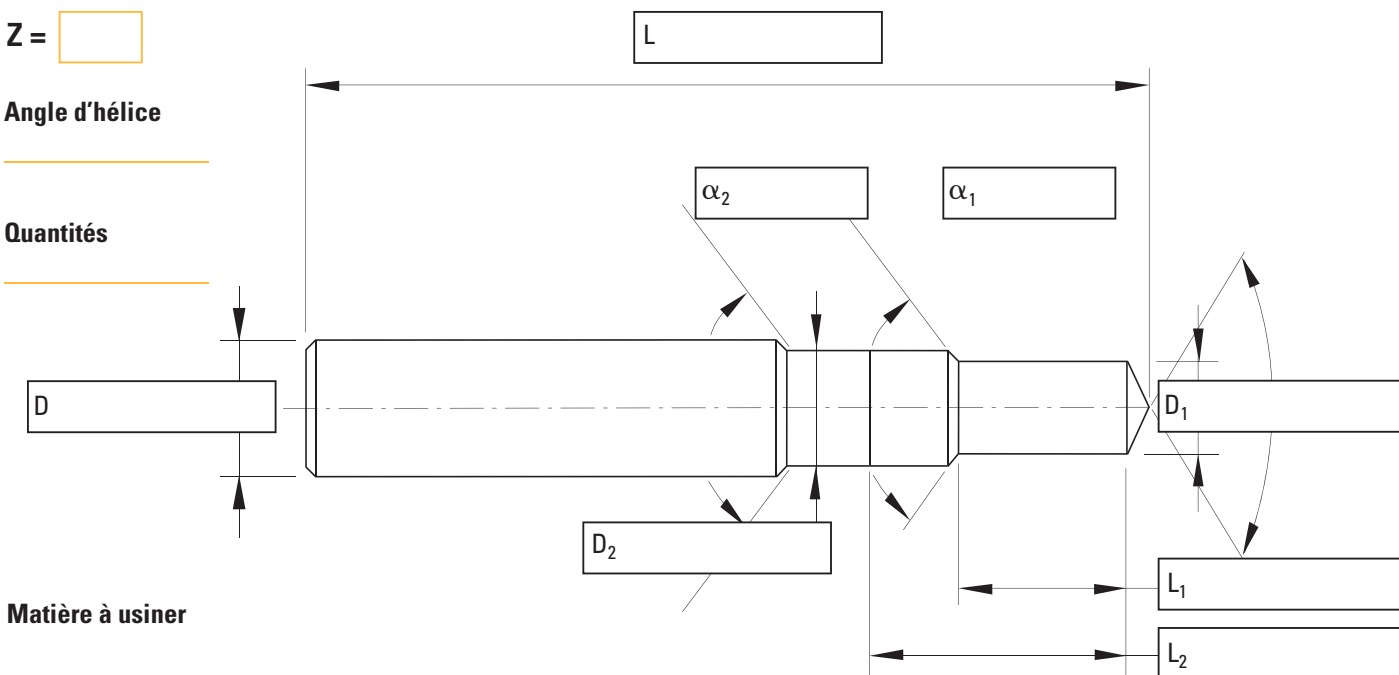

Remarques

CONSULTEZ NOTRE FORMULAIRE DE DEMANDE D'OFFRES EN LIGNE SUR
WWW.DIXIPOLYTOOL.COM





DESSINS POUR COMMANDES
DE FORETS ÉTAGÉS



P. 66
P. 84

DIXI 1503



DIXI 1514 (Z = 1)



Angle d'hélice défini par la matière à usiner.

DIXI 1512 (Z = 2)



DIXI 1518 (Z = 2)



Sauf contre-indication, les tolérances et dimensions standard DIXI seront appliquées.

R L

Z =

Angle d'hélice

Quantités

Matière à usiner

Remarques

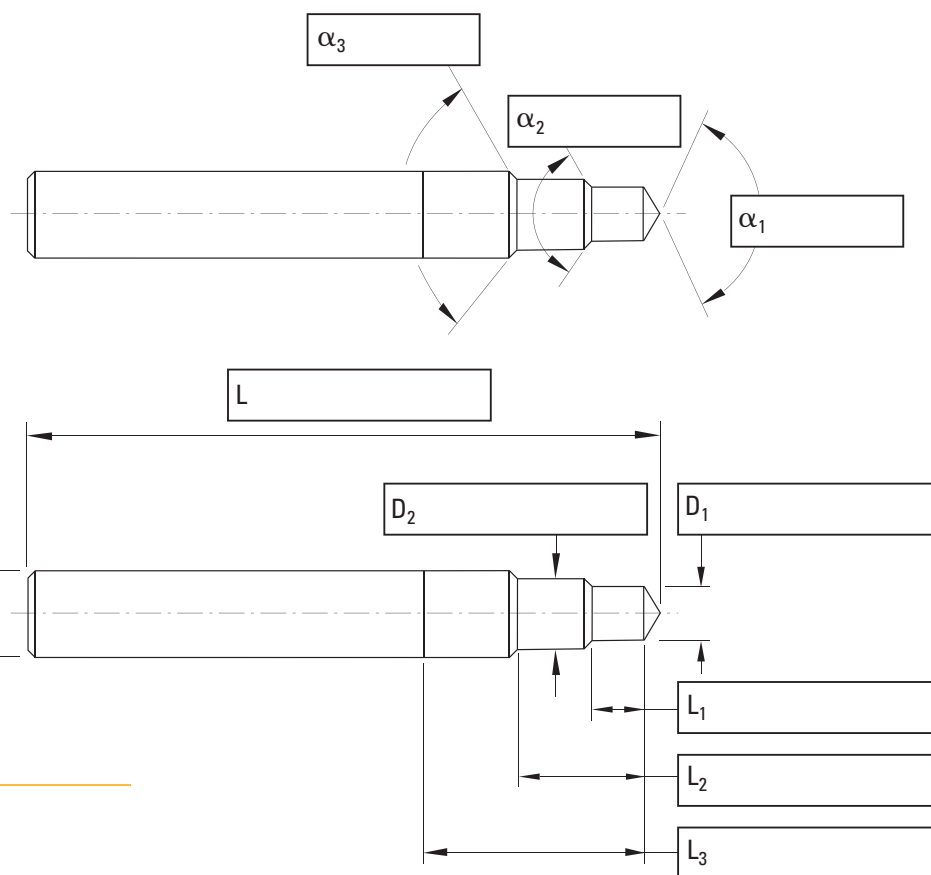

CONSULTEZ NOTRE FORMULAIRE DE DEMANDE D'OFFRES EN LIGNE SUR
WWW.DIXIPOLYTOOL.COM





DESSINS POUR COMMANDES
DE FORETS ÉTAGÉS



P. 66
P. 84

DIXI 1504

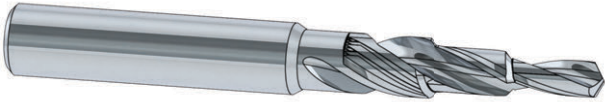

DIXI 1514 (Z = 1)

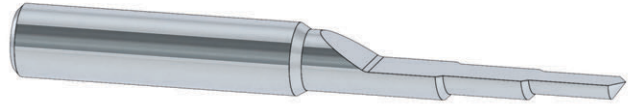

Angle d'hélice défini par la matière à usiner.

DIXI 1512 (Z = 2)

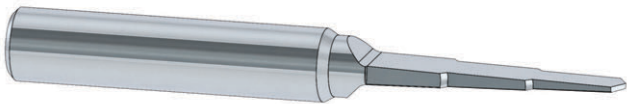

DIXI 1518 (Z = 2)

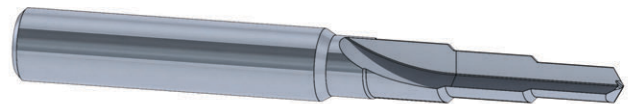

Sauf contre-indication, les tolérances et dimensions standard DIXI seront appliquées.

R L

Z =

Angle d'hélice

Quantités

Matière à usiner

Remarques

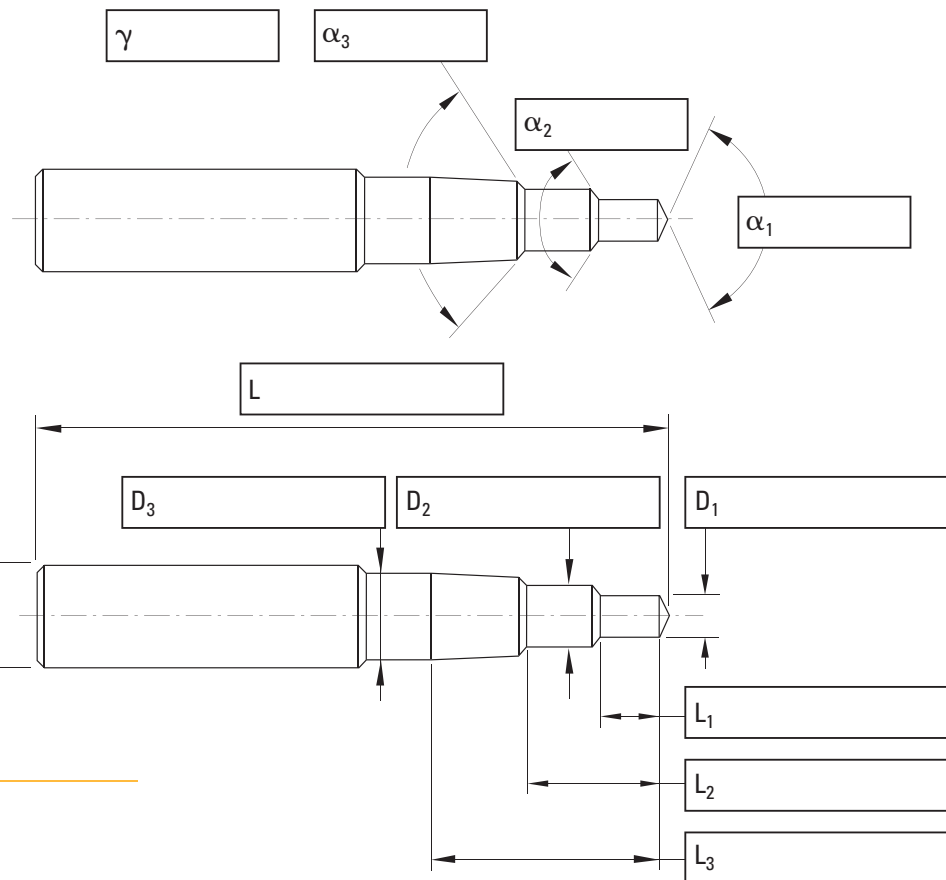

CONSULTEZ NOTRE FORMULAIRE DE DEMANDE D'OFFRES EN LIGNE SUR
WWW.DIXIPOLYTOOL.COM



GÉOMÉTRIE DES FORETS

Le foret hélicoïdal d'usage général est du type que nous illustrons ci-contre. Il peut être cylindrique ou avoir un corps renforcé.

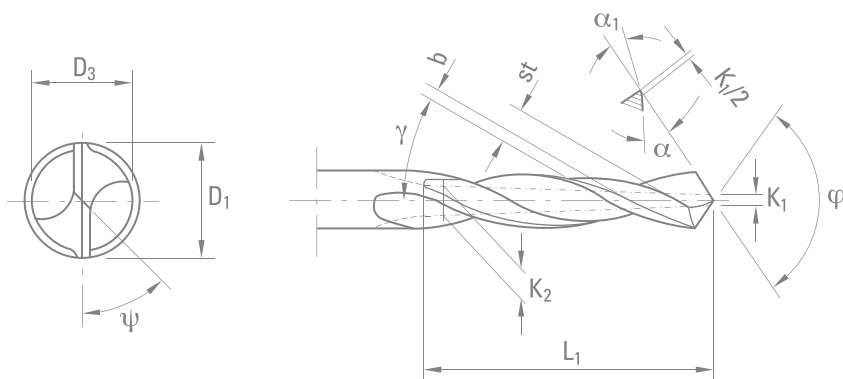

AMINCISSEMENT D'ÂME

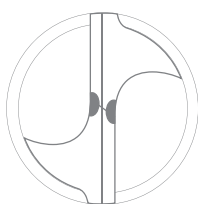

SOLUTION POUR LES PERÇAGES DIFFICILES

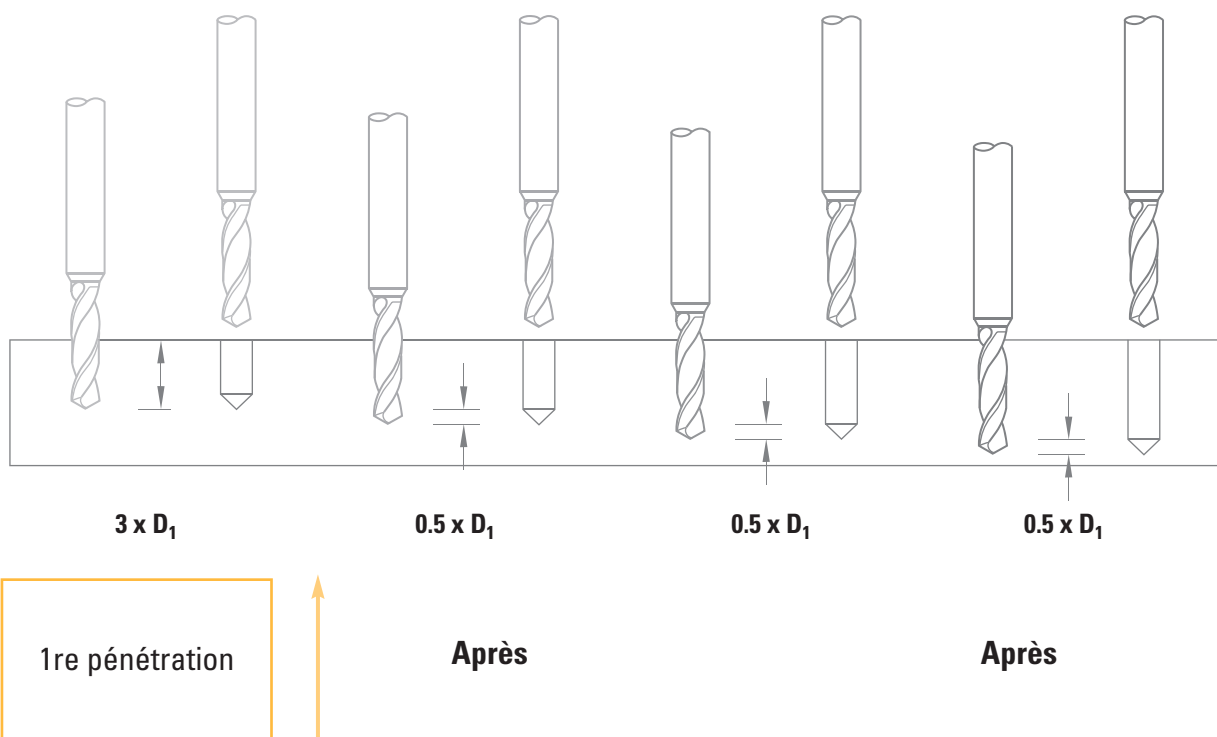

CONDITIONS DE COUPE

Matières à usiner			CARBURE		TiAlN		DICUT	
			Vc [m/min]		Vc [m/min]		Vc [m/min]	
P	Acier non allié / faiblement allié	< 600 N/mm ²	40	60	50	70	50	70
P	Acier non allié / faiblement allié	600 – 1500 N/mm ²	30	50	40	60	40	60
P	Acier de décolletage au plomb		60	90	65	100	65	100
P	Acier fortement allié	700 – 1500 N/mm ²	15	40	25	50	25	50
M	Acier inoxydable	400 – 700 N/mm ²	35	50	40	60	40	60
M	Acier inox. DUPLEX, acier austénitique inox. sans nickel	> 800 N/mm ²	20	40	30	50		
K	Fonte grise / Fonte à graphite sphéroïdal perlitique	< 250 HB	30	50	40	60		
K	Fonte alliée / Fonte à graphite sphéroïdal perlitique	> 250 HB	30	50	40	60		
K	Fonte à graphite sphéroïdal ferritique / Fonte malléable		10	30	20	40		
S	Super alliages / Acier inox. réfractaire	Inconel Nimonic Hastelloy	10	25	20	50		
S	Titane, alliage de titane		40	70				
N	Alliage de cuivre / bonne usinabilité (laiton – bronze)		90	120	100	130	100	130
N	Alliage de cuivre / usinabilité difficile / Bronze à l'aluminium	(CuAlFe) (Ampco)	80	100	90	120		
N	Alliage d'aluminium	Si < 8%	90	150	120	160		
N	Fonte d'aluminium	Si > 8%	70	110	90	130		
N	Plastique		30	60	50	80		
N	Or, argent		50	80	65	100		



$$n \text{ [tr/min]} = \frac{Vc \text{ [m/min]} \times 1000}{\pi \times D_1 \text{ [mm]}}$$

$$Vf \text{ [mm/min]} = n \text{ [tr/min]} \times f \text{ [mm]}$$

Avance par tour **f [mm]**

Ø D ₁ 0.50 - 1.00	Ø D ₁ 1.00 - 1.50	Ø D ₁ 1.50 - 2.00	Ø D ₁ 2.00 - 3.00	Ø D ₁ 3.00 - 5.00	Ø D ₁ 5.00 - 7.00	Ø D ₁ 7.00 - 10.00	Ø D ₁ 10.00 - 14.00	Ø D ₁ 14.00 - 16.00	Ø D ₁ 16.00 - 20.00
0.009 - 0.020	0.016 - 0.030	0.024 - 0.04	0.03 - 0.05	0.05 - 0.10	0.08 - 0.14	0.11 - 0.20	0.16 - 0.28	0.22 - 0.32	0.26 - 0.40
0.007 - 0.015	0.013 - 0.023	0.020 - 0.03	0.03 - 0.04	0.04 - 0.08	0.07 - 0.11	0.09 - 0.15	0.13 - 0.21	0.18 - 0.24	0.21 - 0.30
0.009 - 0.020	0.016 - 0.030	0.024 - 0.04	0.03 - 0.05	0.05 - 0.10	0.08 - 0.14	0.11 - 0.20	0.16 - 0.28	0.22 - 0.32	0.26 - 0.40
0.006 - 0.015	0.011 - 0.023	0.017 - 0.03	0.02 - 0.04	0.03 - 0.08	0.06 - 0.11	0.08 - 0.15	0.11 - 0.21	0.15 - 0.24	0.18 - 0.30
0.007 - 0.015	0.013 - 0.023	0.020 - 0.03	0.03 - 0.04	0.04 - 0.08	0.07 - 0.11	0.09 - 0.15	0.13 - 0.21	0.18 - 0.24	0.21 - 0.30
0.006 - 0.015	0.011 - 0.023	0.017 - 0.03	0.02 - 0.04	0.03 - 0.08	0.06 - 0.11	0.08 - 0.15	0.11 - 0.21	0.15 - 0.24	0.18 - 0.30
0.006 - 0.015	0.011 - 0.023	0.017 - 0.03	0.02 - 0.04	0.03 - 0.08	0.06 - 0.11	0.08 - 0.15	0.11 - 0.21	0.15 - 0.24	0.18 - 0.30
0.007 - 0.015	0.013 - 0.023	0.020 - 0.03	0.03 - 0.04	0.04 - 0.08	0.07 - 0.11	0.09 - 0.15	0.13 - 0.21	0.18 - 0.24	0.21 - 0.30
0.006 - 0.015	0.011 - 0.020	0.017 - 0.03	0.02 - 0.04	0.03 - 0.08	0.06 - 0.11	0.08 - 0.15	0.11 - 0.21	0.15 - 0.24	0.18 - 0.30
0.006 - 0.015	0.011 - 0.023	0.017 - 0.03	0.02 - 0.04	0.03 - 0.08	0.06 - 0.11	0.08 - 0.15	0.11 - 0.21	0.15 - 0.24	0.18 - 0.30
0.009 - 0.020	0.016 - 0.030	0.024 - 0.04	0.03 - 0.05	0.05 - 0.10	0.08 - 0.14	0.11 - 0.20	0.16 - 0.28	0.22 - 0.32	0.26 - 0.40
0.011 - 0.030	0.020 - 0.045	0.030 - 0.06	0.04 - 0.08	0.06 - 0.15	0.10 - 0.21	0.14 - 0.30	0.20 - 0.42	0.28 - 0.48	0.32 - 0.60
0.011 - 0.030	0.020 - 0.045	0.030 - 0.06	0.04 - 0.08	0.06 - 0.15	0.10 - 0.21	0.14 - 0.30	0.20 - 0.42	0.28 - 0.48	0.32 - 0.60
0.011 - 0.030	0.020 - 0.045	0.030 - 0.06	0.04 - 0.08	0.06 - 0.15	0.10 - 0.21	0.14 - 0.30	0.20 - 0.42	0.28 - 0.48	0.32 - 0.60
0.011 - 0.030	0.020 - 0.045	0.030 - 0.06	0.04 - 0.08	0.06 - 0.15	0.10 - 0.21	0.14 - 0.30	0.20 - 0.42	0.28 - 0.48	0.32 - 0.60
0.013 - 0.045	0.027 - 0.068	0.041 - 0.09	0.05 - 0.11	0.08 - 0.23	0.14 - 0.32	0.19 - 0.45	0.27 - 0.63	0.38 - 0.72	0.43 - 0.90
0.011 - 0.030	0.020 - 0.045	0.030 - 0.06	0.04 - 0.08	0.06 - 0.15	0.10 - 0.21	0.14 - 0.30	0.20 - 0.42	0.28 - 0.48	0.32 - 0.60



CONDITIONS DE COUPE

Matières à usiner

		CARBURE	
		Vc [m/min]	
P	Acier de décolletage au plomb	40	60
N	Alliage de cuivre / bonne usinabilité (laiton – bronze)	50	70
N	Alliage de cuivre / usinabilité difficile / Bronze à l'aluminium (CuAlFe) (Ampco)	30	50
N	Or, argent	30	60
N	Plastique	30	60

DIXI 1112 - 1118 - 1512 - 1518

		CARBURE	
		Vc [m/min]	
P	Acier non allié / faiblement allié < 600 N/mm ²	20	40
P	Acier de décolletage au plomb	40	60
K	Fonte à graphite sphéroïdal ferritique / Fonte malléable	20	40
N	Alliage de cuivre / bonne usinabilité (laiton – bronze)	50	80
N	Alliage de cuivre / usinabilité difficile / Bronze à l'aluminium (CuAlFe) (Ampco)	30	50
N	Alliage d'aluminium Si < 8%	60	100
N	Fonte d'aluminium Si > 8%	50	90
N	Plastique	30	60



$$n \text{ [tr/min]} = \frac{Vc \text{ [m/min]} \times 1000}{\pi \times D_1 \text{ [mm]}}$$

$$Vf \text{ [mm/min]} = n \text{ [tr/min]} \times f \text{ [mm]}$$

Avance par tour **f [mm]**

$\emptyset D_1$ 0.08 - 0.70	$\emptyset D_1$ 0.70 - 1.00	$\emptyset D_1$ 1.00 - 1.50	$\emptyset D_1$ 1.50 - 2.00	$\emptyset D_1$ 2.00 - 3.00	$\emptyset D_1$ 3.00 - 4.00	$\emptyset D_1$ 4.00 - 6.00
0.001 - 0.011	0.008 - 0.016	0.012 - 0.02	0.02 - 0.03	0.02 - 0.05	0.04 - 0.06	0.05 - 0.10
0.001 - 0.018	0.011 - 0.025	0.015 - 0.04	0.02 - 0.05	0.03 - 0.08	0.05 - 0.10	0.06 - 0.15
0.001 - 0.011	0.008 - 0.016	0.012 - 0.024	0.018 - 0.032	0.024 - 0.048	0.04 - 0.06	0.05 - 0.10
0.001 - 0.018	0.011 - 0.025	0.015 - 0.04	0.02 - 0.05	0.03 - 0.08	0.05 - 0.10	0.06 - 0.15
0.002 - 0.004	0.003 - 0.059	0.036 - 0.08	0.05 - 0.10	0.06 - 0.14	0.09 - 0.22	0.13 - 0.29

Avance par tour **f [mm]**

$\emptyset D_1$ 0.08 - 0.70	$\emptyset D_1$ 0.70 - 1.00	$\emptyset D_1$ 1.00 - 1.50	$\emptyset D_1$ 1.50 - 2.00	$\emptyset D_1$ 2.00 - 3.00	$\emptyset D_1$ 3.00 - 4.00	$\emptyset D_1$ 4.00 - 6.00
0.001 - 0.011	0.008 - 0.016	0.012 - 0.024	0.018 - 0.032	0.024 - 0.048	0.04 - 0.06	0.05 - 0.10
0.001 - 0.011	0.008 - 0.016	0.012 - 0.024	0.018 - 0.032	0.024 - 0.048	0.04 - 0.06	0.05 - 0.10
0.001 - 0.009	0.008 - 0.013	0.011 - 0.020	0.017 - 0.026	0.022 - 0.039	0.03 - 0.05	0.04 - 0.08
0.001 - 0.018	0.011 - 0.025	0.015 - 0.038	0.023 - 0.050	0.030 - 0.075	0.05 - 0.10	0.06 - 0.15
0.001 - 0.011	0.008 - 0.016	0.012 - 0.024	0.018 - 0.032	0.024 - 0.048	0.04 - 0.06	0.05 - 0.10
0.001 - 0.018	0.011 - 0.025	0.015 - 0.038	0.023 - 0.050	0.030 - 0.075	0.05 - 0.10	0.06 - 0.15
0.001 - 0.018	0.011 - 0.025	0.015 - 0.038	0.023 - 0.050	0.030 - 0.075	0.05 - 0.10	0.06 - 0.15
0.002 - 0.004	0.003 - 0.059	0.036 - 0.08	0.05 - 0.10	0.06 - 0.14	0.09 - 0.22	0.13 - 0.29

$D_1 < 1\text{mm} \Rightarrow Vc - 30\%$



CONDITIONS DE COUPE

Matières à usiner			CARBURE		DICUT	
			Vc [m/min]		Vc [m/min]	
P	Acier non allié / faiblement allié	< 600 N/mm ²	40	60	50	70
P	Acier non allié / faiblement allié	600 – 1500 N/mm ²			30	40
P	Acier de décolletage au plomb		70	100		
P	Acier fortement allié	700 – 1500 N/mm ²			25	40
M	Acier inoxydable	400 – 700 N/mm ²			45	60
M	Acier inox. DUPLEX, acier austénitique inox. sans nickel	> 800 N/mm ²			30	50
K	Fonte grise / Fonte à graphite sphéroïdal perlitique	< 250 HB	50	80	60	90
K	Fonte alliée / Fonte à graphite sphéroïdal perlitique	> 250 HB	40	70	50	80
K	Fonte à graphite sphéroïdal ferritique / Fonte malléable				40	60
S	Super alliages / Acier inox. réfractaire	Inconel Nimonic Hastelloy			20	40
S	Titane, alliage de titane		30	50		
N	Alliage de cuivre / bonne usinabilité (laiton – bronze)		80	100		
N	Alliage de cuivre / usinabilité difficile / Bronze à l'aluminium	(CuAlFe) (Ampeco)	40	70	50	80
N	Alliage d'aluminium	Si < 8%	90	110	120	130
N	Fonte d'aluminium	Si > 8%	70	110	90	130
N	Plastique		30	60		
N	Or, argent		50	80		

$$n \text{ [tr/min]} = \frac{Vc \text{ [m/min]} \times 1000}{\pi \times D_1 \text{ [mm]}}$$

$$Vf \text{ [mm/min]} = n \text{ [tr/min]} \times f \text{ [mm]}$$

Avance par tour **f [mm]**

$\emptyset D_1$ 1.00 - 1.50	$\emptyset D_1$ 1.50 - 2.00	$\emptyset D_1$ 2.00 - 3.00	$\emptyset D_1$ 3.00 - 4.00	$\emptyset D_1$ 4.00 - 5.00	$\emptyset D_1$ 5.00 - 6.00	$\emptyset D_1$ 6.00 - 8.00	$\emptyset D_1$ 8.00 - 10.00	$\emptyset D_1$ 10.00 - 12.00	$\emptyset D_1$ 12.00 - 14.00
0.014 - 0.032	0.027 - 0.041	0.034 - 0.06	0.05 - 0.08	0.06 - 0.09	0.07 - 0.11	0.08 - 0.14	0.11 - 0.18	0.14 - 0.22	0.17 - 0.25
0.011 - 0.025	0.023 - 0.032	0.029 - 0.05	0.04 - 0.06	0.05 - 0.07	0.06 - 0.08	0.07 - 0.11	0.10 - 0.14	0.12 - 0.17	0.14 - 0.20
0.014 - 0.032	0.027 - 0.041	0.034 - 0.06	0.05 - 0.08	0.06 - 0.09	0.07 - 0.11	0.08 - 0.14	0.11 - 0.18	0.14 - 0.22	0.17 - 0.25
0.008 - 0.023	0.020 - 0.030	0.024 - 0.04	0.03 - 0.05	0.04 - 0.07	0.05 - 0.08	0.06 - 0.10	0.08 - 0.13	0.10 - 0.16	0.12 - 0.18
0.011 - 0.025	0.023 - 0.032	0.029 - 0.05	0.04 - 0.06	0.05 - 0.07	0.06 - 0.08	0.07 - 0.11	0.10 - 0.14	0.12 - 0.17	0.14 - 0.20
0.008 - 0.023	0.020 - 0.030	0.024 - 0.04	0.03 - 0.05	0.04 - 0.07	0.05 - 0.08	0.06 - 0.10	0.08 - 0.13	0.10 - 0.16	0.12 - 0.18
0.011 - 0.025	0.023 - 0.032	0.029 - 0.05	0.04 - 0.06	0.05 - 0.07	0.06 - 0.08	0.07 - 0.11	0.10 - 0.14	0.12 - 0.17	0.14 - 0.20
0.008 - 0.023	0.020 - 0.030	0.024 - 0.04	0.03 - 0.05	0.04 - 0.07	0.05 - 0.08	0.06 - 0.10	0.08 - 0.13	0.10 - 0.16	0.12 - 0.18
0.008 - 0.023	0.020 - 0.030	0.024 - 0.04	0.03 - 0.05	0.04 - 0.07	0.05 - 0.08	0.06 - 0.10	0.08 - 0.13	0.10 - 0.16	0.12 - 0.18
0.008 - 0.023	0.020 - 0.030	0.024 - 0.04	0.03 - 0.05	0.04 - 0.07	0.05 - 0.08	0.06 - 0.10	0.08 - 0.13	0.10 - 0.16	0.12 - 0.18
0.011 - 0.025	0.023 - 0.032	0.029 - 0.05	0.04 - 0.06	0.05 - 0.07	0.06 - 0.08	0.07 - 0.11	0.10 - 0.14	0.12 - 0.17	0.14 - 0.20
0.008 - 0.023	0.020 - 0.030	0.024 - 0.04	0.03 - 0.05	0.04 - 0.07	0.05 - 0.08	0.06 - 0.10	0.08 - 0.13	0.10 - 0.16	0.12 - 0.18
0.014 - 0.032	0.027 - 0.041	0.034 - 0.06	0.05 - 0.08	0.06 - 0.09	0.07 - 0.11	0.08 - 0.14	0.11 - 0.18	0.14 - 0.22	0.17 - 0.25
0.017 - 0.050	0.035 - 0.064	0.043 - 0.09	0.06 - 0.12	0.07 - 0.14	0.09 - 0.17	0.11 - 0.22	0.14 - 0.28	0.18 - 0.34	0.22 - 0.39
0.017 - 0.050	0.035 - 0.064	0.043 - 0.09	0.06 - 0.12	0.07 - 0.14	0.09 - 0.17	0.11 - 0.22	0.14 - 0.28	0.18 - 0.34	0.22 - 0.39
0.021 - 0.072	0.049 - 0.092	0.060 - 0.13	0.08 - 0.17	0.10 - 0.20	0.13 - 0.24	0.15 - 0.32	0.20 - 0.40	0.25 - 0.48	0.30 - 0.56
0.017 - 0.050	0.035 - 0.064	0.043 - 0.09	0.06 - 0.21	0.07 - 0.14	0.09 - 0.17	0.11 - 0.22	0.14 - 0.28	0.18 - 0.34	0.22 - 0.39



CONDITIONS DE COUPE

Matières à usiner

			CARBURE		DICUT		DLC	
			Vc [m/min]		Vc [m/min]		Vc [m/min]	
P	Acier non allié / faiblement allié	< 600 N/mm ²	40	60	50	70		
P	Acier non allié / faiblement allié	600 – 1500 N/mm ²			30	40		
P	Acier de décolletage au plomb		60	90				
P	Acier fortement allié	700 – 1500 N/mm ²			25	40		
K	Fonte grise / Fonte à graphite sphéroïdal perlitique	< 250 HB	50	80	60	90		
K	Fonte alliée / Fonte à graphite sphéroïdal perlitique	> 250 HB			30	50		
K	Fonte à graphite sphéroïdal ferritique / Fonte malléable				40	60		
S	Titane, alliage de titane		30	50				
N	Alliage de cuivre / bonne usinabilité (laiton – bronze)		80	100			90	110
N	Alliage de cuivre / usinabilité difficile / Bronze à l'aluminium	(CuAlFe) (Ampco)	40	70	50	80	50	80
N	Alliage d'aluminium	Si < 8%	80	130			100	150
N	Fonte d'aluminium	Si > 8%	70	110			90	130
N	Plastique		30	60	50	80	50	80
N	Or, argent		50	80	70	100	70	100



$$n \text{ [tr/min]} = \frac{Vc \text{ [m/min]} \times 1000}{\pi \times D_1 \text{ [mm]}}$$

$$Vf \text{ [mm/min]} = n \text{ [tr/min]} \times f \text{ [mm]}$$

Avance par tour **f [mm]**

$\emptyset D_1$ 0.10 - 0.30	$\emptyset D_1$ 0.30 - 1.00	$\emptyset D_1$ 1.00 - 1.50	$\emptyset D_1$ 1.50 - 2.00	$\emptyset D_1$ 2.00 - 3.00	$\emptyset D_1$ 3.00 - 5.00	$\emptyset D_1$ 5.00 - 7.00	$\emptyset D_1$ 7.00 - 10.00	$\emptyset D_1$ 10.00 - 14.00	$\emptyset D_1$ 14.00 - 16.00
0.002 - 0.004	0.003 - 0.028	0.021 - 0.04	0.03 - 0.05	0.04 - 0.07	0.05 - 0.11	0.08 - 0.14	0.11 - 0.20	0.15 - 0.28	0.21 - 0.32
0.002 - 0.004	0.003 - 0.021	0.018 - 0.03	0.03 - 0.04	0.03 - 0.05	0.04 - 0.08	0.07 - 0.11	0.09 - 0.15	0.13 - 0.21	0.18 - 0.24
0.002 - 0.004	0.003 - 0.028	0.021 - 0.04	0.03 - 0.05	0.04 - 0.07	0.05 - 0.11	0.08 - 0.14	0.11 - 0.20	0.15 - 0.28	0.21 - 0.32
0.002 - 0.004	0.003 - 0.020	0.015 - 0.03	0.02 - 0.03	0.03 - 0.05	0.04 - 0.07	0.06 - 0.10	0.08 - 0.14	0.11 - 0.20	0.15 - 0.22
0.002 - 0.004	0.003 - 0.021	0.018 - 0.03	0.03 - 0.04	0.03 - 0.05	0.04 - 0.08	0.07 - 0.11	0.09 - 0.15	0.13 - 0.21	0.18 - 0.24
0.002 - 0.004	0.003 - 0.021	0.015 - 0.03	0.02 - 0.04	0.03 - 0.05	0.04 - 0.07	0.06 - 0.10	0.09 - 0.14	0.11 - 0.20	0.15 - 0.22
0.002 - 0.004	0.003 - 0.020	0.015 - 0.03	0.02 - 0.03	0.03 - 0.05	0.04 - 0.07	0.06 - 0.10	0.08 - 0.14	0.11 - 0.20	0.15 - 0.22
0.002 - 0.004	0.003 - 0.021	0.018 - 0.03	0.03 - 0.04	0.03 - 0.05	0.04 - 0.08	0.07 - 0.11	0.09 - 0.15	0.13 - 0.21	0.18 - 0.24
0.002 - 0.004	0.003 - 0.028	0.021 - 0.04	0.03 - 0.05	0.04 - 0.07	0.05 - 0.11	0.08 - 0.14	0.11 - 0.20	0.15 - 0.28	0.21 - 0.32
0.002 - 0.004	0.003 - 0.020	0.015 - 0.03	0.02 - 0.03	0.03 - 0.05	0.04 - 0.07	0.06 - 0.10	0.08 - 0.14	0.11 - 0.20	0.15 - 0.22
0.002 - 0.004	0.003 - 0.042	0.27 - 0.05	0.04 - 0.07	0.05 - 0.10	0.06 - 0.16	0.10 - 0.21	0.13 - 0.30	0.19 - 0.42	0.27 - 0.48
0.002 - 0.004	0.003 - 0.042	0.027 - 0.05	0.04 - 0.07	0.05 - 0.10	0.06 - 0.16	0.10 - 0.21	0.13 - 0.30	0.19 - 0.42	0.27 - 0.48
0.002 - 0.004	0.003 - 0.059	0.036 - 0.08	0.05 - 0.10	0.06 - 0.14	0.09 - 0.22	0.13 - 0.29	0.18 - 0.42	0.26 - 0.59	0.36 - 0.67
0.002 - 0.004	0.003 - 0.042	0.027 - 0.05	0.04 - 0.07	0.05 - 0.10	0.06 - 0.16	0.10 - 0.21	0.13 - 0.30	0.19 - 0.42	0.27 - 0.48

$D_1 < 1\text{mm} \Rightarrow Vc - 30\%$



CONDITIONS DE COUPE

Matières à usiner			CARBURE		DICUT		DLC	
			Vc [m/min]		Vc [m/min]		Vc [m/min]	
P	Acier non allié / faiblement allié	< 600 N/mm ²	40	60	50	70		
P	Acier non allié / faiblement allié	600 – 1500 N/mm ²			30	40		
P	Acier de décolletage au plomb		60	90				
P	Acier fortement allié	700 – 1500 N/mm ²			25	40		
M	Acier inoxydable	400 – 700 N/mm ²			45	60		
M	Acier inox. DUPLEX, acier austénitique inox. sans nickel	> 800 N/mm ²			30	50		
K	Fonte grise / Fonte à graphite sphéroïdal perlitique	< 250 HB	50	80	60	90		
K	Fonte alliée / Fonte à graphite sphéroïdal perlitique	> 250 HB			30	50		
K	Fonte à graphite sphéroïdal ferritique / Fonte malléable				40	60		
S	Super alliages / Acier inox. réfractaire	Inconel Nimonic Hastelloy			20	40		
S	Titane, alliage de titane		30	50				
N	Alliage de cuivre / bonne usinabilité (laiton – bronze)		80	100			90	110
N	Alliage de cuivre / usinabilité difficile / Bronze à l'aluminium	(CuAlFe) (Ampco)	40	70	50	80	50	80
N	Alliage d'aluminium	Si < 8%	80	130			100	150
N	Fonte d'aluminium	Si > 8%	70	110			90	130
N	Graphite						60	100
N	Plastique		30	60	50	80	50	80
N	Or, argent		50	80	70	100	70	100

$$n \text{ [tr/min]} = \frac{Vc \text{ [m/min]} \times 1000}{\pi \times D_1 \text{ [mm]}}$$

$$Vf \text{ [mm/min]} = n \text{ [tr/min]} \times f \text{ [mm]}$$

Avance par tour **f [mm]**

$\emptyset D_1$ 0.05 - 0.30	$\emptyset D_1$ 0.30 - 1.00	$\emptyset D_1$ 1.00 - 1.50	$\emptyset D_1$ 1.50 - 2.00	$\emptyset D_1$ 2.00 - 2.45	
0.002 - 0.004	0.003 - 0.028	0.021 - 0.04	0.03 - 0.05	0.04 - 0.07	
0.002 - 0.004	0.003 - 0.021	0.018 - 0.03	0.03 - 0.04	0.03 - 0.05	
0.002 - 0.004	0.003 - 0.028	0.021 - 0.04	0.03 - 0.05	0.04 - 0.07	
0.002 - 0.004	0.003 - 0.020	0.015 - 0.03	0.02 - 0.03	0.03 - 0.05	
0.002 - 0.004	0.003 - 0.021	0.018 - 0.03	0.03 - 0.04	0.03 - 0.05	
0.002 - 0.004	0.003 - 0.020	0.015 - 0.03	0.02 - 0.03	0.03 - 0.05	
0.002 - 0.004	0.003 - 0.021	0.018 - 0.03	0.03 - 0.04	0.03 - 0.05	
0.002 - 0.004	0.003 - 0.021	0.015 - 0.03	0.02 - 0.04	0.03 - 0.05	
0.002 - 0.004	0.003 - 0.020	0.015 - 0.03	0.02 - 0.03	0.03 - 0.05	
0.001 - 0.002	0.002 - 0.010	0.015 - 0.02	0.015 - 0.025	0.02 - 0.04	
0.002 - 0.004	0.003 - 0.021	0.018 - 0.03	0.03 - 0.04	0.03 - 0.05	
0.002 - 0.004	0.003 - 0.028	0.021 - 0.04	0.03 - 0.05	0.04 - 0.07	
0.002 - 0.004	0.003 - 0.020	0.015 - 0.03	0.02 - 0.03	0.03 - 0.05	
0.002 - 0.004	0.003 - 0.042	0.27 - 0.05	0.04 - 0.07	0.05 - 0.10	
0.002 - 0.004	0.003 - 0.042	0.027 - 0.05	0.04 - 0.07	0.05 - 0.10	
0.002 - 0.004	0.003 - 0.059	0.036 - 0.08	0.05 - 0.10	0.06 - 0.14	
0.002 - 0.004	0.003 - 0.059	0.036 - 0.08	0.05 - 0.10	0.06 - 0.14	
0.002 - 0.004	0.003 - 0.042	0.027 - 0.05	0.04 - 0.07	0.05 - 0.10	

$D_1 < 1\text{mm} \Rightarrow Vc - 30\%$



CONDITIONS DE COUPE

Matières à usiner			CARBURE		DICUT - TiAlN	
			Vc [m/min]		Vc [m/min]	
P	Acier non allié / faiblement allié	< 600 N/mm ²	40	60	50	70
P	Acier non allié / faiblement allié	600 – 1500 N/mm ²			40	60
P	Acier de décolletage au plomb		60	90		
P	Acier fortement allié	700 – 1500 N/mm ²			40	60
M	Acier inoxydable	400 – 700 N/mm ²	40	60	50	70
M	Acier inox. DUPLEX, acier austénitique inox. sans nickel	> 800 N/mm ²	20	40	30	50
K	Fonte grise / Fonte à graphite sphéroïdal perlitique	< 250 HB	50	80	60	80
K	Fonte alliée / Fonte à graphite sphéroïdal perlitique	> 250 HB	40	60	50	70
K	Fonte à graphite sphéroïdal ferritique / Fonte malléable		30	50	40	60
S	Super alliages / Acier inox. réfractaire	Inconel Nimonic Hastelloy	15	25	20	40
S	Titane, alliage de titane		35	55		
N	Alliage de cuivre / bonne usinabilité (laiton – bronze)		80	100		
N	Alliage de cuivre / usinabilité difficile / Bronze à l'aluminium	(CuAlFe) (Ampco)	40	70	60	90
N	Alliage d'aluminium	Si < 8%	80	100	90	130
N	Fonte d'aluminium	Si > 8%	70	90	80	120
N	Plastique		30	60		
N	Or, argent		50	80		

$$n \text{ [tr/min]} = \frac{Vc \text{ [m/min]} \times 1000}{\pi \times D_1 \text{ [mm]}}$$

$$Vf \text{ [mm/min]} = n \text{ [tr/min]} \times f \text{ [mm]}$$

Avance par tour **f [mm]**

$\emptyset D_1$ 0.05 - 0.30	$\emptyset D_1$ 0.30 - 0.60	$\emptyset D_1$ 0.60 - 0.80	$\emptyset D_1$ 0.80 - 1.00	$\emptyset D_1$ 1.00 - 1.20	$\emptyset D_1$ 1.20 - 1.40	$\emptyset D_1$ 1.40 - 1.60	$\emptyset D_1$ 1.60 - 1.80	$\emptyset D_1$ 1.80 - 2.00	$\emptyset D_1$ 2.00 - 3.00
0.0006 - 0.007	0.004 - 0.014	0.007 - 0.019	0.010 - 0.024	0.012 - 0.029	0.013 - 0.035	0.014 - 0.037	0.016 - 0.041	0.018 - 0.044	0.020 - 0.066
0.0005 - 0.006	0.003 - 0.012	0.006 - 0.015	0.008 - 0.019	0.010 - 0.023	0.011 - 0.028	0.011 - 0.029	0.013 - 0.033	0.014 - 0.035	0.016 - 0.053
0.0007 - 0.009	0.004 - 0.017	0.009 - 0.023	0.012 - 0.029	0.014 - 0.035	0.016 - 0.043	0.017 - 0.044	0.019 - 0.050	0.022 - 0.053	0.024 - 0.079
0.0004 - 0.005	0.003 - 0.010	0.005 - 0.013	0.007 - 0.017	0.008 - 0.020	0.009 - 0.025	0.010 - 0.026	0.011 - 0.029	0.013 - 0.031	0.014 - 0.046
0.0005 - 0.006	0.003 - 0.012	0.006 - 0.015	0.008 - 0.019	0.010 - 0.023	0.011 - 0.028	0.011 - 0.029	0.013 - 0.033	0.014 - 0.035	0.016 - 0.053
0.0004 - 0.005	0.002 - 0.009	0.005 - 0.012	0.006 - 0.016	0.008 - 0.019	0.009 - 0.023	0.009 - 0.024	0.010 - 0.027	0.012 - 0.029	0.013 - 0.043
0.0008 - 0.009	0.005 - 0.018	0.009 - 0.024	0.012 - 0.030	0.015 - 0.036	0.017 - 0.044	0.018 - 0.046	0.020 - 0.052	0.023 - 0.055	0.025 - 0.083
0.0006 - 0.007	0.004 - 0.014	0.007 - 0.019	0.010 - 0.024	0.012 - 0.029	0.013 - 0.035	0.014 - 0.037	0.016 - 0.041	0.018 - 0.044	0.020 - 0.066
0.0006 - 0.007	0.004 - 0.014	0.007 - 0.019	0.010 - 0.024	0.012 - 0.029	0.013 - 0.035	0.014 - 0.037	0.016 - 0.041	0.018 - 0.044	0.020 - 0.066
0.0003 - 0.004	0.002 - 0.007	0.004 - 0.010	0.005 - 0.012	0.006 - 0.014	0.007 - 0.018	0.007 - 0.018	0.008 - 0.021	0.009 - 0.022	0.010 - 0.033
0.0006 - 0.007	0.004 - 0.014	0.007 - 0.019	0.010 - 0.024	0.012 - 0.029	0.013 - 0.035	0.014 - 0.037	0.016 - 0.041	0.018 - 0.044	0.020 - 0.066
0.0008 - 0.009	0.005 - 0.018	0.009 - 0.024	0.012 - 0.030	0.015 - 0.036	0.017 - 0.044	0.018 - 0.046	0.020 - 0.052	0.023 - 0.055	0.025 - 0.083
0.0006 - 0.007	0.004 - 0.014	0.007 - 0.019	0.010 - 0.024	0.012 - 0.029	0.013 - 0.035	0.014 - 0.037	0.016 - 0.041	0.018 - 0.044	0.020 - 0.066
0.0008 - 0.009	0.005 - 0.018	0.009 - 0.024	0.012 - 0.030	0.017 - 0.040	0.018 - 0.050	0.018 - 0.046	0.020 - 0.052	0.023 - 0.055	0.025 - 0.083
0.0006 - 0.007	0.004 - 0.014	0.007 - 0.019	0.010 - 0.024	0.012 - 0.029	0.013 - 0.035	0.014 - 0.037	0.016 - 0.041	0.018 - 0.044	0.020 - 0.066
0.0008 - 0.009	0.005 - 0.018	0.009 - 0.024	0.012 - 0.030	0.017 - 0.040	0.018 - 0.050	0.018 - 0.046	0.020 - 0.052	0.023 - 0.055	0.025 - 0.083
0.0006 - 0.007	0.004 - 0.014	0.007 - 0.019	0.010 - 0.024	0.012 - 0.029	0.013 - 0.035	0.014 - 0.037	0.016 - 0.041	0.018 - 0.044	0.020 - 0.066

$D_1 < 1\text{mm} \Rightarrow Vc - 30\%$



CONDITIONS DE COUPE

Matières à usiner

			CARBURE		DICUT - TiAlN	
			Vc [m/min]		Vc [m/min]	
P	Acier non allié / faiblement allié	< 600 N/mm ²	40	60	50	70
P	Acier de décolletage au plomb		60	90		
P	Acier fortement allié	700 – 1500 N/mm ²	15	30	20	40
M	Acier inoxydable	400 – 700 N/mm ²	35	50	40	60
K	Fonte grise / Fonte à graphite sphéroïdal perlitique	< 250 HB	50	80	60	80
K	Fonte à graphite sphéroïdal ferritique / Fonte malléable		30	50	40	60
S	Titane, alliage de titane		30	50		
N	Alliage de cuivre / bonne usinabilité (laiton – bronze)		80	100		
N	Alliage de cuivre / usinabilité difficile / Bronze à l'aluminium	(CuAlFe) (Ampco)	40	70	50	80
N	Alliage d'aluminium	Si < 8%	80	100	90	110
N	Plastique		30	60		
N	Or, argent		50	80		

$$n \text{ [tr/min]} = \frac{Vc \text{ [m/min]} \times 1000}{\pi \times D_1 \text{ [mm]}}$$

$$Vf \text{ [mm/min]} = n \text{ [tr/min]} \times f \text{ [mm]}$$

Avance par tour **f [mm]**

$\emptyset D_1$ 0.20 - 0.70	$\emptyset D_1$ 0.70 - 1.00	$\emptyset D_1$ 1.00 - 1.50	$\emptyset D_1$ 1.50 - 2.00	$\emptyset D_1$ 2.00 - 3.00	$\emptyset D_1$ 3.00 - 4.00	$\emptyset D_1$ 4.00 - 5.00	$\emptyset D_1$ 5.00 - 6.00	
0.005 - 0.013	0.010 - 0.018	0.014 - 0.04	0.02 - 0.05	0.04 - 0.06	0.04 - 0.09	0.06 - 0.10	0.08 - 0.11	
0.005 - 0.013	0.010 - 0.018	0.014 - 0.04	0.02 - 0.05	0.04 - 0.06	0.04 - 0.09	0.06 - 0.10	0.08 - 0.11	
0.003 - 0.009	0.007 - 0.013	0.010 - 0.03	0.02 - 0.05	0.03 - 0.04	0.03 - 0.06	0.04 - 0.07	0.06 - 0.08	
0.005 - 0.010	0.008 - 0.014	0.012 - 0.03	0.02 - 0.035	0.03 - 0.05	0.04 - 0.07	0.05 - 0.08	0.07 - 0.08	
0.004 - 0.010	0.008 - 0.014	0.012 - 0.03	0.02 - 0.035	0.03 - 0.05	0.04 - 0.07	0.05 - 0.08	0.07 - 0.08	
0.004 - 0.010	0.008 - 0.014	0.012 - 0.03	0.02 - 0.04	0.03 - 0.05	0.04 - 0.07	0.05 - 0.08	0.07 - 0.08	
0.003 - 0.009	0.007 - 0.013	0.010 - 0.03	0.02 - 0.04	0.03 - 0.04	0.03 - 0.06	0.04 - 0.07	0.06 - 0.08	
0.006 - 0.020	0.013 - 0.028	0.018 - 0.05	0.03 - 0.06	0.05 - 0.09	0.05 - 0.13	0.07 - 0.15	0.10 - 0.17	
0.005 - 0.013	0.010 - 0.018	0.014 - 0.04	0.02 - 0.05	0.04 - 0.06	0.04 - 0.09	0.06 - 0.10	0.08 - 0.11	
0.006 - 0.020	0.013 - 0.028	0.018 - 0.05	0.03 - 0.06	0.05 - 0.09	0.05 - 0.13	0.07 - 0.15	0.10 - 0.17	
0.008 - 0.028	0.018 - 0.040	0.025 - 0.08	0.04 - 0.08	0.07 - 0.13	0.08 - 0.19	0.10 - 0.22	0.14 - 0.24	
0.006 - 0.020	0.013 - 0.028	0.018 - 0.05	0.03 - 0.06	0.05 - 0.09	0.05 - 0.13	0.07 - 0.15	0.10 - 0.17	

$D_1 < 1\text{mm} \Rightarrow Vc - 30\%$



CONDITIONS DE COUPE

Matières à usiner			Ø D ₁ < 2.00		Ø D ₁ ≥ 2.00	
			TiAlN Vc [m/min]		TiAlN Vc [m/min]	
P	Acier non allié / faiblement allié	< 600 N/mm ²	30	60	70	90
P	Acier non allié / faiblement allié	600 – 1500 N/mm ²	35	50	40	60
P	Acier fortement allié	700 – 1500 N/mm ²	15	30	70	90
M	Acier inoxydable	400 – 700 N/mm ²	10	25	35	50
K	Fonte grise / Fonte à graphite sphéroïdal perlitique	< 250 HB	30	60	70	100
K	Fonte alliée / Fonte à graphite sphéroïdal perlitique	> 250 HB	10	25	50	80
K	Fonte à graphite sphéroïdal ferritique / Fonte malléable		15	30	50	80
S	Super alliages / Acier inox. réfractaire	Inconel Nimonic Hastelloy	10	25	15	35
S	Titane, alliage de titane		20	45	40	70
N	Alliage de cuivre / usinabilité difficile / Bronze à l'aluminium	(CuAlFe) (Ampco)	50	90	90	110
N	Alliage d'aluminium	Si < 8%	90	120	100	130

DIXI 1149

			TiAlN Vc [m/min]	
P	Acier non allié / faiblement allié	< 600 N/mm ²	70	90
P	Acier non allié / faiblement allié	600 – 1500 N/mm ²	40	60
P	Acier fortement allié	700 – 1500 N/mm ²	35	50
M	Acier inoxydable	400 – 700 N/mm ²	35	50
K	Fonte grise / Fonte à graphite sphéroïdal perlitique	< 250 HB	70	100
K	Fonte alliée / Fonte à graphite sphéroïdal perlitique	> 250 HB	40	60
K	Fonte à graphite sphéroïdal ferritique / Fonte malléable		30	50
S	Super alliages / Acier inox. réfractaire	Inconel Nimonic Hastelloy	12	30
S	Titane, alliage de titane		30	60
N	Alliage de cuivre / usinabilité difficile / Bronze à l'aluminium	(CuAlFe) (Ampco)	70	90
N	Alliage d'aluminium	Si < 8%	130	160



$$n \text{ [tr/min]} = \frac{Vc \text{ [m/min]} \times 1000}{\pi \times D_1 \text{ [mm]}}$$

$$Vf \text{ [mm/min]} = n \text{ [tr/min]} \times f \text{ [mm]}$$

Avance par tour **f [mm]**

$\emptyset D_1$ < 1.00	$\emptyset D_1$ 1.00 - 2.00	$\emptyset D_1$ 2.00 - 3.00	$\emptyset D_1$ 3.00 - 4.50	$\emptyset D_1$ 4.50 - 6.00	$\emptyset D_1$ 6.00 - 7.00	$\emptyset D_1$ 7.00 - 8.00	$\emptyset D_1$ 8.00 - 10.00	$\emptyset D_1$ 10.00 - 12.00	$\emptyset D_1$ 12.00 - 14.00
0.02 - 0.03	0.03 - 0.05	0.03 - 0.06	0.04 - 0.10	0.08 - 0.12	0.10 - 0.14	0.11 - 0.16	0.13 - 0.20	0.15 - 0.25	0.20 - 0.30
0.01 - 0.02	0.015 - 0.04	0.02 - 0.05	0.04 - 0.08	0.07 - 0.09	0.08 - 0.11	0.09 - 0.12	0.10 - 0.15	0.13 - 0.18	0.16 - 0.20
0.005 - 0.008	0.007 - 0.012	0.01 - 0.04	0.03 - 0.08	0.07 - 0.09	0.08 - 0.11	0.09 - 0.12	0.10 - 0.15	0.13 - 0.18	0.16 - 0.20
0.005 - 0.008	0.009 - 0.02	0.01 - 0.04	0.03 - 0.08	0.06 - 0.09	0.07 - 0.11	0.08 - 0.12	0.09 - 0.15	0.12 - 0.18	0.15 - 0.20
0.02 - 0.03	0.03 - 0.04	0.04 - 0.05	0.04 - 0.08	0.07 - 0.09	0.08 - 0.11	0.09 - 0.12	0.10 - 0.15	0.13 - 0.18	0.16 - 0.20
0.01 - 0.02	0.02 - 0.03	0.03 - 0.04	0.03 - 0.08	0.06 - 0.09	0.07 - 0.11	0.08 - 0.12	0.09 - 0.15	0.12 - 0.18	0.15 - 0.20
0.02 - 0.03	0.03 - 0.04	0.04 - 0.05	0.04 - 0.08	0.07 - 0.09	0.08 - 0.11	0.09 - 0.12	0.10 - 0.15	0.13 - 0.18	0.16 - 0.20
0.004 - 0.01	0.005 - 0.015	0.005 - 0.02	0.012 - 0.04	0.02 - 0.05	0.03 - 0.08	0.04 - 0.09	0.05 - 0.11	0.06 - 0.12	0.07 - 0.15
0.008 - 0.02	0.01 - 0.03	0.01 - 0.04	0.03 - 0.08	0.06 - 0.09	0.07 - 0.11	0.08 - 0.12	0.09 - 0.15	0.12 - 0.18	0.15 - 0.20
0.03 - 0.04	0.04 - 0.05	0.045 - 0.06	0.05 - 0.10	0.08 - 0.12	0.10 - 0.14	0.11 - 0.16	0.13 - 0.20	0.16 - 0.25	0.20 - 0.30
0.04 - 0.05	0.05 - 0.06	0.06 - 0.08	0.07 - 0.12	0.09 - 0.14	0.11 - 0.16	0.12 - 0.18	0.14 - 0.22	0.18 - 0.28	0.22 - 0.32

$\emptyset D_1$ 1.00 - 2.00	$\emptyset D_1$ 2.00 - 3.00	$\emptyset D_1$ 3.00 - 4.00	$\emptyset D_1$ 4.00 - 5.00	$\emptyset D_1$ 5.00 - 6.00	$\emptyset D_1$ 6.00 - 7.00	$\emptyset D_1$ 7.00 - 8.00	$\emptyset D_1$ 8.00 - 9.00	$\emptyset D_1$ 9.00 - 10.00	$\emptyset D_1$ 10.00 - 14.00
0.02 - 0.04	0.03 - 0.06	0.04 - 0.09	0.06 - 0.11	0.08 - 0.12	0.10 - 0.14	0.11 - 0.16	0.13 - 0.18	0.15 - 0.20	0.15 - 0.30
0.02 - 0.04	0.02 - 0.05	0.04 - 0.07	0.05 - 0.08	0.07 - 0.09	0.08 - 0.11	0.09 - 0.12	0.10 - 0.14	0.12 - 0.15	0.13 - 0.20
0.01 - 0.03	0.01 - 0.40	0.03 - 0.07	0.05 - 0.08	0.07 - 0.09	0.07 - 0.11	0.08 - 0.12	0.09 - 0.14	0.12 - 0.15	0.12 - 0.20
0.01 - 0.03	0.01 - 0.04	0.03 - 0.07	0.05 - 0.08	0.07 - 0.09	0.08 - 0.11	0.09 - 0.12	0.09 - 0.14	0.12 - 0.15	0.12 - 0.20
0.02 - 0.04	0.04 - 0.05	0.04 - 0.07	0.05 - 0.08	0.07 - 0.09	0.08 - 0.11	0.09 - 0.12	0.10 - 0.14	0.12 - 0.15	0.13 - 0.20
0.02 - 0.04	0.04 - 0.05	0.04 - 0.07	0.05 - 0.08	0.07 - 0.09	0.08 - 0.11	0.09 - 0.12	0.10 - 0.14	0.12 - 0.15	0.13 - 0.20
0.02 - 0.04	0.03 - 0.04	0.03 - 0.07	0.05 - 0.08	0.07 - 0.09	0.07 - 0.11	0.08 - 0.12	0.09 - 0.14	0.12 - 0.15	0.12 - 0.20
0.008 - 0.03	0.01 - 0.03	0.03 - 0.07	0.05 - 0.08	0.07 - 0.09	0.07 - 0.11	0.08 - 0.12	0.09 - 0.14	0.12 - 0.15	0.12 - 0.20
0.008 - 0.03	0.01 - 0.03	0.03 - 0.07	0.05 - 0.08	0.07 - 0.09	0.07 - 0.12	0.08 - 0.12	0.09 - 0.14	0.12 - 0.15	0.12 - 0.20
0.02 - 0.04	0.02 - 0.06	0.05 - 0.08	0.06 - 0.10	0.08 - 0.12	0.10 - 0.14	0.11 - 0.16	0.13 - 0.18	0.13 - 0.20	0.16 - 0.30
0.02 - 0.04	0.02 - 0.06	0.05 - 0.08	0.06 - 0.10	0.08 - 0.12	0.10 - 0.14	0.11 - 0.16	0.13 - 0.18	0.13 - 0.20	0.16 - 0.30



CONDITIONS DE COUPE
Matières à usiner

			TiAlN	
			Vc [m/min]	
P	Acier non allié / faiblement allié	< 600 N/mm ²	80	120
P	Acier non allié / faiblement allié	600 – 1500 N/mm ²	70	100
P	Acier de décolletage au plomb		80	120
P	Acier fortement allié	700 – 1500 N/mm ²	40	70
M	Acier inox. DUPLEX, acier austénitique inox. sans nickel	> 800 N/mm ²	30	50
K	Fonte grise / Fonte à graphite sphéroïdal perlitique	< 250 HB	90	130
K	Fonte allié / Fonte à graphite sphéroïdal perlitique	> 250 HB	80	120
K	Fonte à graphite sphéroïdal ferritique / Fonte malléable		70	100
S	Super alliages / Acier inox. réfractaire	Inconel Nimonic Hastelloy	15	30
S	Titane, alliage de titane		50	100
N	Alliage d'aluminium	Si < 8%	140	170

DIXI 1147

			TiAlN	
			Vc [m/min]	
P	Acier non allié / faiblement allié	< 600 N/mm ²	70	100
P	Acier non allié / faiblement allié	600 – 1500 N/mm ²	60	90
P	Acier de décolletage au plomb		80	110
P	Acier fortement allié	700 – 1500 N/mm ²	30	60
M	Acier inox. DUPLEX, acier austénitique inox. sans nickel	> 800 N/mm ²	30	50
K	Fonte grise / Fonte à graphite sphéroïdal perlitique	< 250 HB	90	130
K	Fonte allié / Fonte à graphite sphéroïdal perlitique	> 250 HB	80	120
K	Fonte à graphite sphéroïdal ferritique / Fonte malléable		70	100
S	Super alliages / Acier inox. réfractaire	Inconel Nimonic Hastelloy	15	30
S	Titane, alliage de titane		50	100
N	Alliage d'aluminium	Si < 8%	130	160



$$n \text{ [tr/min]} = \frac{V_c \text{ [m/min]} \times 1000}{\pi \times D_1 \text{ [mm]}}$$

$$V_f \text{ [mm/min]} = n \text{ [tr/min]} \times f \text{ [mm]}$$

Avance par tour **f [mm]**

Ø D ₁ 0.80 - 1.00	Ø D ₁ 1.00 - 1.50	Ø D ₁ 1.50 - 2.00	Ø D ₁ 2.00 - 3.00	Ø D ₁ 3.00 - 5.00	Ø D ₁ 5.00 - 7.00	Ø D ₁ 7.00 - 10.00
0.03 - 0.11	0.06 - 0.16	0.08 - 0.21	0.11 - 0.25	0.13 - 0.27	0.16 - 0.33	0.19 - 0.35
0.03 - 0.10	0.06 - 0.15	0.08 - 0.20	0.10 - 0.23	0.12 - 0.25	0.15 - 0.27	0.18 - 0.30
0.03 - 0.12	0.07 - 0.17	0.09 - 0.23	0.11 - 0.25	0.14 - 0.27	0.17 - 0.30	0.21 - 0.35
0.03 - 0.10	0.06 - 0.15	0.08 - 0.17	0.12 - 0.22	0.12 - 0.23	0.15 - 0.25	0.18 - 0.28
0.008 - 0.02	0.01 - 0.04	0.02 - 0.06	0.03 - 0.08	0.04 - 0.10	0.05 - 0.12	0.07 - 0.14
0.03 - 0.12	0.07 - 0.17	0.09 - 0.23	0.12 - 0.29	0.14 - 0.35	0.17 - 0.40	0.21 - 0.46
0.03 - 0.12	0.07 - 0.17	0.09 - 0.23	0.12 - 0.29	0.14 - 0.35	0.17 - 0.40	0.21 - 0.46
0.03 - 0.10	0.06 - 0.15	0.08 - 0.20	0.10 - 0.25	0.12 - 0.30	0.15 - 0.35	0.18 - 0.40
0.008 - 0.02	0.01 - 0.04	0.02 - 0.06	0.03 - 0.08	0.04 - 0.10	0.05 - 0.12	0.07 - 0.14
0.008 - 0.02	0.01 - 0.04	0.02 - 0.06	0.03 - 0.08	0.04 - 0.10	0.05 - 0.12	0.07 - 0.14
0.03 - 0.12	0.07 - 0.17	0.09 - 0.23	0.12 - 0.29	0.14 - 0.35	0.17 - 0.40	0.21 - 0.46

Ø D ₁ 0.50 - 1.00	Ø D ₁ 1.00 - 1.50	Ø D ₁ 1.50 - 2.00	Ø D ₁ 2.00 - 3.00	Ø D ₁ 3.00 - 5.00	Ø D ₁ 5.00 - 7.00	Ø D ₁ 7.00 - 10.00
0.03 - 0.11	0.06 - 0.16	0.08 - 0.21	0.11 - 0.26	0.13 - 0.32	0.16 - 0.37	0.19 - 0.42
0.03 - 0.10	0.06 - 0.15	0.08 - 0.20	0.10 - 0.25	0.12 - 0.30	0.15 - 0.35	0.18 - 0.40
0.03 - 0.12	0.07 - 0.17	0.09 - 0.23	0.12 - 0.29	0.14 - 0.35	0.17 - 0.40	0.21 - 0.46
0.03 - 0.10	0.06 - 0.15	0.08 - 0.20	0.12 - 0.25	0.12 - 0.30	0.15 - 0.35	0.18 - 0.40
0.008 - 0.02	0.01 - 0.04	0.02 - 0.06	0.03 - 0.08	0.04 - 0.10	0.05 - 0.12	0.07 - 0.14
0.03 - 0.12	0.07 - 0.17	0.09 - 0.23	0.12 - 0.29	0.14 - 0.35	0.17 - 0.40	0.21 - 0.46
0.03 - 0.12	0.07 - 0.17	0.09 - 0.23	0.12 - 0.29	0.14 - 0.35	0.17 - 0.40	0.21 - 0.46
0.03 - 0.10	0.06 - 0.15	0.08 - 0.20	0.10 - 0.25	0.12 - 0.30	0.15 - 0.35	0.18 - 0.40
0.008 - 0.02	0.01 - 0.04	0.02 - 0.06	0.03 - 0.08	0.04 - 0.10	0.05 - 0.12	0.07 - 0.14
0.008 - 0.02	0.01 - 0.04	0.02 - 0.06	0.03 - 0.08	0.04 - 0.10	0.05 - 0.12	0.07 - 0.14
0.03 - 0.10	0.06 - 0.15	0.08 - 0.20	0.10 - 0.25	0.12 - 0.30	0.15 - 0.35	0.18 - 0.40



CONDITIONS DE COUPE

Matières à usiner

			CARBURE	
			Vc [m/min]	
P	Acier non allié / faiblement allié	< 600 N/mm ²	40	60
P	Acier non allié / faiblement allié	600 – 1500 N/mm ²	35	50
P	Acier de décolletage au plomb		60	90
K	Fonte grise / Fonte à graphite sphéroïdal perlitique	< 250 HB	50	80
K	Fonte alliée / Fonte à graphite sphéroïdal perlitique	> 250 HB	35	50
K	Fonte à graphite sphéroïdal ferritique / Fonte malléable		40	55
S	Titane, alliage de titane		30	50
N	Alliage de cuivre / bonne usinabilité (laiton – bronze)		60	100
N	Fonte d'aluminium	Si > 8%	70	110
N	Or, argent		50	80

DIXI 1280

			XIDUR	
			Vc [m/min]	
P	Acier fortement allié	700 – 1500 N/mm ²	30	30
H	Acier à outils et fontes trempés	> 1500 N/mm ² (45 - 65 HRC)	15	25
S	Super alliages / Acier inox. réfractaire	Inconel Nimonic Hastelloy	15	30



$$n \text{ [tr/min]} = \frac{Vc \text{ [m/min]} \times 1000}{\pi \times D_1 \text{ [mm]}}$$

$$Vf \text{ [mm/min]} = n \text{ [tr/min]} \times f \text{ [mm]}$$

Avance par tour **f [mm]**

Ø D ₁ 0.15 - 0.50	Ø D ₁ 0.50 - 1.00	Ø D ₁ 1.00 - 1.50	Ø D ₁ 1.50 - 2.00	Ø D ₁ 2.00 - 3.00	Ø D ₁ 3.00 - 5.00	Ø D ₁ 5.00 - 7.00	Ø D ₁ 7.00 - 10.00	Ø D ₁ 10.00 - 14.00
0.0012 - 0.009	0.004 - 0.018	0.008 - 0.028	0.011 - 0.037	0.011 - 0.05	0.020 - 0.07	0.03 - 0.10	0.04 - 0.14	0.06 - 0.19
0.001 - 0.007	0.003 - 0.015	0.006 - 0.022	0.010 - 0.029	0.008 - 0.04	0.016 - 0.06	0.03 - 0.08	0.04 - 0.12	0.05 - 0.15
0.0014 - 0.011	0.005 - 0.022	0.010 - 0.033	0.014 - 0.044	0.013 - 0.06	0.023 - 0.09	0.04 - 0.12	0.05 - 0.07	0.07 - 0.23
0.0015 - 0.012	0.005 - 0.023	0.010 - 0.035	0.015 - 0.046	0.013 - 0.06	0.024 - 0.09	0.04 - 0.13	0.06 - 0.18	0.08 - 0.24
0.0012 - 0.009	0.004 - 0.018	0.008 - 0.028	0.011 - 0.037	0.011 - 0.05	0.020 - 0.07	0.03 - 0.10	0.04 - 0.14	0.06 - 0.19
0.0012 - 0.009	0.004 - 0.018	0.008 - 0.028	0.011 - 0.037	0.011 - 0.05	0.020 - 0.07	0.03 - 0.10	0.04 - 0.14	0.06 - 0.19
0.0012 - 0.009	0.004 - 0.018	0.008 - 0.028	0.011 - 0.037	0.011 - 0.05	0.020 - 0.07	0.03 - 0.10	0.04 - 0.14	0.06 - 0.19
0.0015 - 0.012	0.005 - 0.023	0.010 - 0.035	0.015 - 0.046	0.013 - 0.06	0.024 - 0.09	0.04 - 0.13	0.06 - 0.18	0.08 - 0.24
0.0017 - 0.013	0.006 - 0.026	0.011 - 0.039	0.017 - 0.052	0.015 - 0.07	0.027 - 0.10	0.04 - 0.14	0.06 - 0.20	0.09 - 0.27
0.0012 - 0.009	0.004 - 0.018	0.008 - 0.028	0.011 - 0.037	0.011 - 0.05	0.020 - 0.07	0.03 - 0.10	0.04 - 0.14	0.06 - 0.19

D₁ < 1mm ⇒ Vc - 30 %

Ø D ₁ 0.25 - 0.50	Ø D ₁ 0.50 - 1.00	Ø D ₁ 1.00 - 2.50	Ø D ₁ 2.50 - 3.00	Ø D ₁ 3.00 - 4.00	Ø D ₁ 4.00 - 5.00	Ø D ₁ 5.00 - 8.00	Ø D ₁ 8.00 - 12.00
0.015	0.022	0.03	0.035	0.044	0.055	0.06	0.08
0.01	0.02	0.025	0.03	0.04	0.05	0.05	0.06
0.015	0.022	0.03	0.035	0.044	0.055	0.06	0.08

Cycle de débourage = 0.25 x D₁



CONDITIONS DE COUPE

Matières à usiner			CARBURE		TiAlN	
			Vc [m/min]		Vc [m/min]	
P	Acier non allié / faiblement allié	< 600 N/mm ²	40	60	50	70
P	Acier non allié / faiblement allié	600 – 1500 N/mm ²	30	50	40	60
P	Acier de décolletage au plomb		60	90	70	100
P	Acier fortement allié	700 – 1500 N/mm ²	35	50	25	50
M	Acier inoxydable	400 – 700 N/mm ²	15	40	40	60
M	Acier inox. DUPLEX, acier austénitique inox. sans nickel	> 800 N/mm ²	30	50	40	60
K	Fonte grise / Fonte à graphite sphéroïdal perlitique	< 250 HB	10	30	60	90
K	Fonte alliée / Fonte à graphite sphéroïdal perlitique	> 250 HB	50	80	40	60
K	Fonte à graphite sphéroïdal ferritique / Fonte malléable		30	50	40	60
S	Super alliages / Acier inox. réfractaire	Inconel Nimonic Hastelloy	20	40	30	50
S	Titane, alliage de titane		30	50	40	60
N	Alliage de cuivre / bonne usinabilité (laiton – bronze)		80	100	90	120
N	Alliage de cuivre / usinabilité difficile / Bronze à l'aluminium	(CuAlFe) (Ampeco)	40	70	60	80
N	Alliage d'aluminium	Si < 8%	80	120	100	160
N	Fonte d'aluminium	Si > 8%	70	110	90	130
N	Plastique		30	60	50	80
N	Or, argent		50	80	65	100

On utilise généralement le **Ø moyen** du foret étagé pour le calcul de la rotation de la broche (n)

$$n \text{ [tr/min]} = \frac{Vc \text{ [m/min]} \times 1000}{\pi \times D_1 \text{ [mm]}}$$

$$Vf \text{ [mm/min]} = n \text{ [tr/min]} \times f \text{ [mm]}$$

Avance par tour **f [mm]**

Ø D ₁ 0.30 - 1.00	Ø D ₁ 1.00 - 1.50	Ø D ₁ 1.50 - 2.00	Ø D ₁ 2.00 - 3.00	Ø D ₁ 3.00 - 5.00	Ø D ₁ 5.00 - 7.00	Ø D ₁ 7.00 - 10.00	Ø D ₁ 10.00 - 14.00	Ø D ₁ 14.00 - 16.00	Ø D ₁ 16.00 - 20.00
0.003 - 0.018	0.014 - 0.027	0.021 - 0.04	0.03 - 0.05	0.04 - 0.09	0.07 - 0.13	0.10 - 0.18	0.14 - 0.25	0.20 - 0.29	0.22 - 0.36
0.002 - 0.014	0.012 - 0.021	0.018 - 0.03	0.02 - 0.04	0.04 - 0.07	0.06 - 0.10	0.08 - 0.14	0.12 - 0.20	0.17 - 0.22	0.19 - 0.28
0.003 - 0.018	0.014 - 0.027	0.021 - 0.04	0.03 - 0.05	0.04 - 0.09	0.07 - 0.13	0.10 - 0.18	0.14 - 0.25	0.20 - 0.29	0.22 - 0.36
0.002 - 0.014	0.012 - 0.021	0.018 - 0.03	0.02 - 0.04	0.04 - 0.07	0.06 - 0.10	0.08 - 0.14	0.12 - 0.20	0.17 - 0.22	0.19 - 0.28
0.002 - 0.013	0.010 - 0.020	0.015 - 0.03	0.02 - 0.03	0.03 - 0.07	0.05 - 0.09	0.07 - 0.13	0.10 - 0.18	0.14 - 0.21	0.16 - 0.26
0.002 - 0.014	0.012 - 0.021	0.018 - 0.03	0.02 - 0.04	0.04 - 0.07	0.06 - 0.10	0.08 - 0.14	0.12 - 0.20	0.17 - 0.22	0.19 - 0.28
0.002 - 0.013	0.010 - 0.02	0.015 - 0.03	0.02 - 0.03	0.03 - 0.07	0.05 - 0.09	0.07 - 0.13	0.10 - 0.18	0.14 - 0.21	0.16 - 0.26
0.002 - 0.014	0.012 - 0.021	0.018 - 0.03	0.02 - 0.04	0.04 - 0.07	0.06 - 0.10	0.08 - 0.14	0.12 - 0.20	0.17 - 0.22	0.19 - 0.28
0.002 - 0.013	0.010 - 0.020	0.015 - 0.03	0.02 - 0.03	0.03 - 0.07	0.05 - 0.09	0.07 - 0.13	0.10 - 0.18	0.14 - 0.21	0.16 - 0.26
0.001 - 0.008	0.006 - 0.010	0.008 - 0.02	0.01 - 0.03	0.02 - 0.04	0.03 - 0.06	0.04 - 0.08	0.06 - 0.11	0.07 - 0.12	0.08 - 0.14
0.002 - 0.013	0.010 - 0.020	0.015 - 0.03	0.02 - 0.03	0.03 - 0.07	0.05 - 0.09	0.07 - 0.13	0.10 - 0.18	0.14 - 0.21	0.16 - 0.26
0.004 - 0.028	0.018 - 0.042	0.027 - 0.06	0.04 - 0.07	0.05 - 0.14	0.09 - 0.20	0.13 - 0.28	0.18 - 0.39	0.25 - 0.45	0.29 - 0.56
0.003 - 0.018	0.014 - 0.027	0.021 - 0.04	0.03 - 0.05	0.04 - 0.09	0.07 - 0.13	0.10 - 0.18	0.14 - 0.25	0.20 - 0.29	0.22 - 0.36
0.004 - 0.028	0.018 - 0.042	0.027 - 0.06	0.04 - 0.07	0.05 - 0.14	0.09 - 0.20	0.13 - 0.28	0.18 - 0.39	0.25 - 0.45	0.29 - 0.56
0.004 - 0.028	0.018 - 0.042	0.027 - 0.06	0.04 - 0.07	0.05 - 0.14	0.09 - 0.20	0.13 - 0.28	0.18 - 0.39	0.25 - 0.45	0.29 - 0.56
0.005 - 0.040	0.025 - 0.060	0.038 - 0.08	0.05 - 0.10	0.08 - 0.20	0.13 - 0.28	0.18 - 0.40	0.25 - 0.56	0.35 - 0.64	0.40 - 0.80
0.004 - 0.028	0.018 - 0.042	0.027 - 0.06	0.04 - 0.07	0.05 - 0.14	0.09 - 0.20	0.13 - 0.28	0.18 - 0.39	0.25 - 0.45	0.29 - 0.56

D₁ < 1mm ⇒ Vc - 30 %

